

AGRICULTURE IN THE AMERICAS AT THE BEGINNING OF THE 1990s

*Volume I:
Principal changes in production and trade*

0000 76 84

IICA
E16
1

● **Inter-American Institute for Cooperation on Agriculture (IICA).**
September 1993.

All rights reserved. Reproduction of this book, in whole or in part, is prohibited without the express authorization of the Inter-American Institute for Cooperation on Agriculture (IICA).

The views expressed in signed articles are those of the authors and do not necessarily reflect those of the Inter-American Institute for Cooperation on Agriculture.

The Directorate for the Coordination of Institutional Affairs (DICA), through its Language Services Unit, translated this publication to English.

The Inter-American Agricultural Documentation and Information Center (CIDIA), through its Editorial Service and Print Shop, was responsible for the stylistic, layout and printing of this publication.

Agriculture in the Americas at the beginning of the 1990s.
Principal changes in production and trade / Instituto Interamericano de Cooperación para la Agricultura. — San José, C.R. : IICA, 1993.
2 v. ; 28 cm.

Publicado también en español: La agricultura de las Américas al inicio de la década de los noventa. Principales transformaciones productivas y de comercio.

ISBN 92-9039-225-8 (v.1)

1. Estructura de la producción — América. 2. Productividad — América. 3. Comercio exterior — América. I. IICA.
II. Título.

AGRIS
E16

DEWEY
338.1091812

TABLE OF CONTENTS

	Page
INTRODUCTION	5
METHODOLOGICAL ASPECTS	7
Arrangement of Countries into Groups	7
Data Sources	7
Description of Variables	8
CHANGES IN THE PRODUCTION STRUCTURE	11
Harvested Area, Production and Land Use	11
Comparison of Production by Commodity	18
Comparison of Production by Groups of Countries	27
CHANGES IN PRODUCTIVITY AND USE OF FACTORS	39
Yield of Basic Commodities	39
Utilization of Factors of Production	39
AGRICULTURAL AND OVERALL TRADE	45
Total Agricultural Exports and Exports by Groups of Products	45

Dominant Exporting Countries by Selected Commodities	47
Exports by Groups of Countries	54
Overall Exports by Area	54
Agricultural Imports: Overall and by Groups of Commodities	61
Imports by Groups of Countries	64
Overall imports	64
Agricultural Trade Balance	64
BIBLIOGRAPHY	73
LIST OF FIGURES	75

INTRODUCTION

Agriculture in the Americas, hard hit by the crisis of the 1980s, now faces the challenge of achieving sustainable development in the context of a market economy. The modernization of agriculture, proposed as a solution to that crisis, has been favored by the change of approach in agriculture, from traditional sector to expanded sector, which recognizes its capacity for stimulating economic through production linkages. The growing openness, the liberalization of economies, the revitalization of subregional integration processes and the downsizing of the State are some of the features of the context in which change is taking place.

Generating proposals for the changing the production structure at the regional level demands a sound knowledge of the agricultural sector. The purpose of this document is to offer an overview of the scale of agricultural production and an appraisal of the major changes agriculture in the Americas has undergone in recent years. The principal changes that have taken place in production and trade in the Americas during the last two decades are examined through statistical data, indicators and charts. In geographical terms, the results are presented by country, area or subregion and consolidated at the regional level.

Interpreting the data is left to the readers' discretion, so that they may draw their own conclusions. Only an explanatory description of the direction and magnitude of the most significant changes is provided.

The first section presents information on changes in the production structure, with emphasis on changing patterns in the areas harvested, production and land use. The second deals with the development of productivity. The third section provides an analysis of foreign trade, including overall imports and exports of agricultural products as a whole and separately. These three sections are illustrated with charts.

The information is set out by blocs. The first, consisting of Latin America and the Caribbean (LAC), is subdivided into four areas: Central, Caribbean, Andean and Southern. The second includes the countries of the North American Free Trade Agreement (NAFTA): Canada, the United States of America and Mexico, which is compared with the rest of the Americas. The other group of countries is known as the Group of 3: Colombia, Mexico and Venezuela, which is contrasted to the rest of LAC.

In the last 20 years, a relatively short period in the long history of agriculture in the Americas, some highly significant changes have taken place; however, certain conditions have also remained unaltered, a fact we tend to overlook. A few examples of changes are: the areas used for soybeans increased almost tenfold, while those for corn remained static, despite large subsidies in the developed countries and falling prices; notwithstanding significant progress in diversification, grains continue to be the dominant commodity group; poultry meat now accounts for 31 percent of overall meat production, whereas the figure was 15 percent 20 years ago; exports of vegetables, fruits and nuts from LAC increased by more than 500 percent and are now worth more than US\$3 billion; grain imports in the Group of 3, in relation to the rest of LAC, have increased from 25 to

46 percent. A brief analysis of structural conditions also reveals data that call for reflection; for instance, the forested area of LAC is around 60 percent, while the U.S. and Canada together total 40 percent; the U.S. produces more than twice as much grain as LAC (being the world's main exporter), but LAC produces almost double the amount of fruits and vegetables grown in the U.S.; 90 percent of the irrigated lands are concentrated in six countries, largely in Brazil, Chile, Mexico and Peru.

The material is presented in two volumes. This first volume provides certain indicators of interest and Volume II presents detailed country-by-country and product-by-product statistics. This project was carried out by the Directorate of the Agricultural Policy Analysis and Planning Program, under Dr. Carlos Pomareda, with the assistance of Rosario Bogantes, Manuel Jimenez and Rolando Piskulich.

Martin E. Piñeiro
Director General
IICA

METHODOLOGICAL ASPECTS

This section on methodology explains the criteria for selection and arrangement of countries by groups; identifies data sources; and provides a description of the variables, based on the document files of the information systems used.

Arrangement of Countries into Groups

In preparing this report, the inclusion of countries was conditioned by the availability of acceptable statistics in the sources selected. The arrangement of countries into groups does not always coincide with the classifications used in the data sources.

Central Area: Costa Rica, Dominican Republic, El Salvador, Guatemala, Honduras, Mexico, Nicaragua and Panama.

Caribbean Area: Barbados, Belize, Cuba, Guyana, Haiti, Jamaica, and Trinidad and Tobago.

Andean Area: Bolivia, Colombia, Ecuador, Peru and Venezuela.

Southern Area: Argentina, Brazil, Chile, Paraguay and Uruguay.

Latin America and the Caribbean: Includes the following countries of the Central, Caribbean, Andean and Southern areas: Argentina, Barbados, Belize, Bolivia, Brazil, Chile, Colombia, Costa Rica, Cuba, Dominican Republic, Ecuador, El Salvador, Guatemala, Guyana, Haiti, Honduras, Jamaica, Mexico, Nicaragua, Panama, Paraguay, Peru, Trinidad and Tobago, Uruguay, and Venezuela.

North American Free Trade Agreement (NAFTA): Canada, United States of America, and Mexico.

Group of 3: Colombia, Mexico and Venezuela.

Data Sources

The information contained in this document corresponds to data or material obtained from the following sources:

SIAPA: Information System for Agricultural Policy Analysis. Inter-American Institute for

Cooperation on Agriculture (IICA), Program I.

WATI: World Agriculture: Trends and Indicators, 1961-1989. United States Department of Agriculture (USDA), Economic Research Service.

Description of Variables

The following description of variables was prepared on the basis of the definitions used by the abovementioned data sources:

- **Factors of production**

Arable lands and perennial croplands: Arable lands include those used for annual crops, garden crops and crops that are left temporarily fallow. Perennial croplands are lands that are not sown after every crop (fruit, rubber and other trees, for example). It excludes lands used for timber trees.

Permanent pasturelands: Lands used to cultivate fodder for five years or longer.

Irrigated area: Lands intentionally supplied with water.

Tractors per thousand hectares: Ratio of the number of tractors and the area allotted to arable lands and perennial crops.

Tractors per thousand farm workers: Ratio of the number of tractors in use to the agricultural labor force (economically active population in agriculture).

- **Area and yield**

Grains: Includes wheat, rye, rice, corn, barley, oats, sorghum, millet and other grains produced in small amounts.

— **Unhulled rice.** All classes and grades (based on paddy rice).

— **Corn.** All classes and grades.

— **Wheat.** All classes and grades.

— **Sorghum.** All classes and grades.

Soybeans: Unprocessed.

Sugar: Centrifugal sugar, raw.

Fruit: Includes watermelons, melons, grapes, apples, pears, peaches, nectarines, plums, oranges, lemons, limes, tangerines, grapefruit, pineapples, bananas, plantains, mangoes, papayas, apricots, avocados, strawberries and raspberries.

Vegetables: Includes cabbages, artichokes, tomatoes, cauliflowers, squash, cucumbers, eggplants, chili peppers, peppers, onions, garlic, green beans, peas and carrots.

Coffee: Green coffee.

Ginned cotton: Cotton separated from the seed.

Milk: Cow's, buffalo's, sheep's and goat's milk.

- **Value of agricultural trade**

Vegetable oils: Includes soybean, rapeseed, cottonseed, sunflower and peanut oils.

Livestock: Includes livestock used in milk and meat production, such as beef and dairy cattle, sheep, goats and pigs.

Cotton: Cotton fiber.

Sugar: Centrifugal sugar, raw.

Bananas: Refers, where possible, to edible species of fruit of the genus *Musa*, with the exception of *M. paradisiaca*, known as plantain.

Coffee: All grades of processed and unprocessed coffee.

Meat: Meat products marketed for consumption.

Grains: Wheat, rice, corn, barley, sorghum, millet, rye and by-products of the above.

Fibers: Cotton, wool, hemp, sisal and others.

Tobacco and by-products: Processed and unprocessed tobacco.

Vegetables, fruits and nuts: Root crops, legumes, tomatoes, onions, oranges, tangerines and other citrus fruits, bananas, apples, grapes, raisins, coconuts, pears, peaches, pineapples, dates, watermelons, cantaloupes and other melons, figs, Brazil nuts, cashew nuts, almonds, walnuts, pistachios, hazelnuts, areca palm nuts, peanuts and other nuts (unspecified).

CHANGES IN THE PRODUCTION STRUCTURE

Harvested Area, Production and Land Use

Harvested Area

The evolution of areas harvested for selected agricultural commodities (rice, soybeans, wheat, corn, coffee and bananas) in LAC (Figure 1) during the three periods considered in the analysis (1970, 1980 and 1989) shows major concentrations in the Southern Area, where five of the six products studied are predominant, especially rice, wheat and soybeans. The Central Area has a high proportion of harvested area in bananas, corn and coffee. The Andean Area's largest contributions to regional totals are in coffee and bananas, and the Caribbean Area's contributions are relatively low in each case.

Harvested areas in rice present increasing rates in the Andean and Central Areas and remain stable in the Caribbean Area; in the Southern Area, however, a definite contrast may be observed: an increase followed by a smaller decrease in harvested area.

The evolution of the harvested area in soybeans at the regional level replicates the clear upward trend of the Southern Area. The area allotted to that crop in the remaining three areas is of lesser importance in relative terms.

As to wheat, the situation is similar to soybeans, that is, a clear predominance of the Southern Area, with an evident upward trend, and a minor share of the total wheat production area for the rest of the region.

As concerns the area used for corn production, contrasting trends can be observed in the two areas with the largest shares: increasing rates in the Southern Area and a decrease in the Central Area.

In regard to coffee, the Southern, Central and Andean Areas show significant shares of the harvested area, as well as similar increases in production, and the harvested area in the Caribbean Area remains relatively stable.

The situation regarding bananas in the three selected years shows an upward trend in the Southern Area and a downturn followed by a recovery in the Andean Area. The Central Area underwent a period of stagnation followed by an increase, while slight growth was registered in the harvested area for bananas in the Caribbean Area.

Production of Basic Commodities

Figure 2 shows the performance of basic commodities production during the periods considered in the analysis (1970, 1980 and 1989), grouped into three charts. The first chart displays the upward trend in grain production, both as a whole and for each of the main types of grain, and of soybeans. The second chart shows the uneven performance of a set of export products: sugar and coffee experience an upward trend; cotton production is stable, whereas bananas show a downward trend, followed by a sharp rise to a point above the initial starting point. The third chart includes production of beef and poultry meat, and fruits and vegetables, all of which show rising rates and follow similar patterns in the three years selected for the analysis.

Land Use

Land use trends in LAC during the two decades in question reflect an average annual decrease of 0.49 percent in forested areas, whereas the areas for arable lands and perennial crops rose 1.16 percent annually, with a 0.40 percent rise in permanent pasturelands (Figure 3).

Figure 4 shows a general decrease in the forested area of LAC; in the U.S. it remains constant and then rises, and in Canada the area increases during the years studied.

Irrigated Area

In regard to the irrigated area (Figure 5), two groups of countries are identified, according to the number of hectares under irrigation. The first group consists of countries with more than 500,000 hectares, the most prominent being Mexico, with almost four million hectares of irrigated land in 1970. In 1987, Mexico and Brazil stand out, the former with five million and the latter with about three million hectares under irrigation. In the group with less than 500,000 irrigated hectares, Venezuela and Colombia are worthy of special note.

Figure 1
LAC: Harvested Area by Area
in 1970, 1980 and 1989
(Millions of hectares)

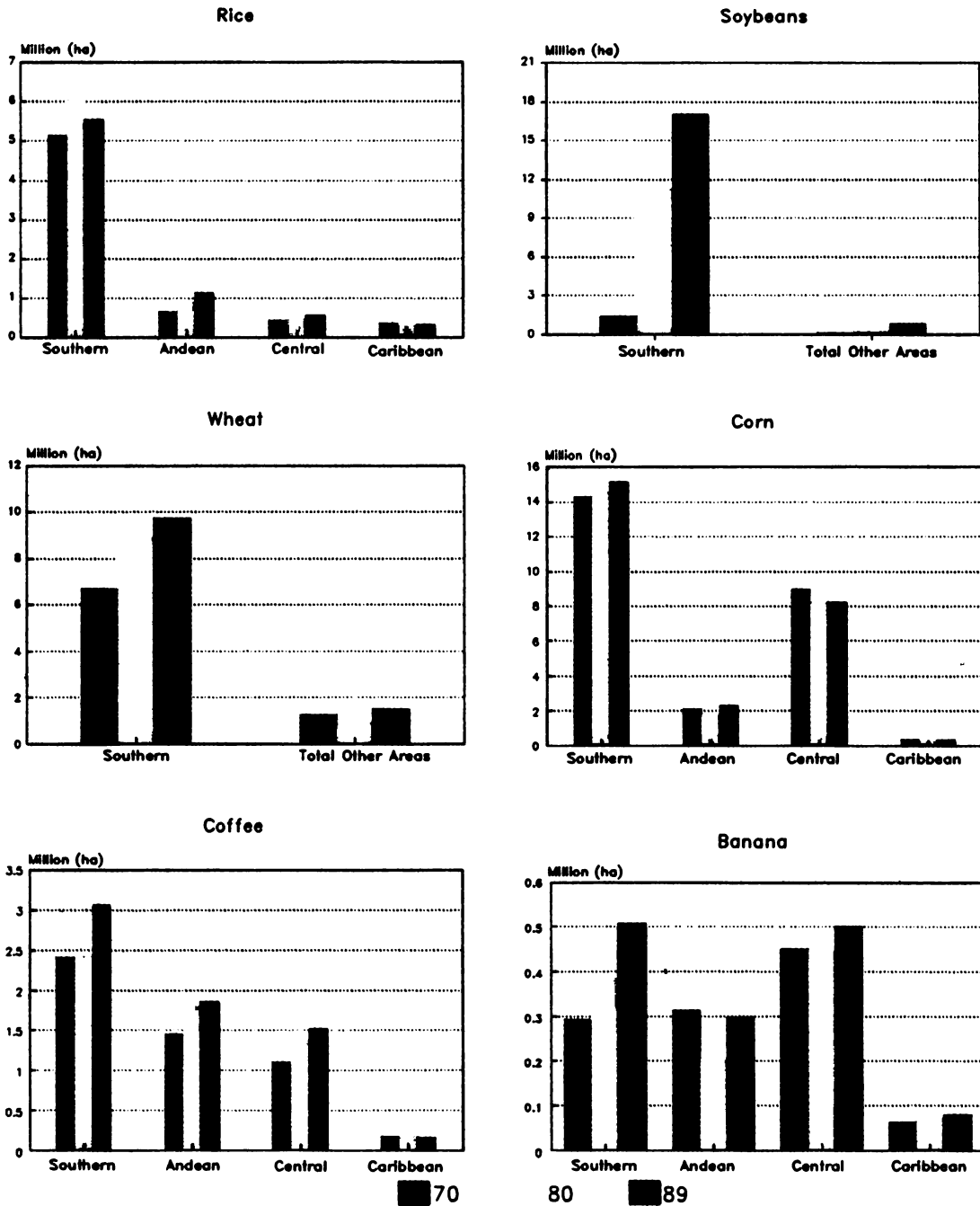

Figure 2

LAC: Volume of Production of Commodities
in 1970, 1980 and 1989
(Millions of metric tons)

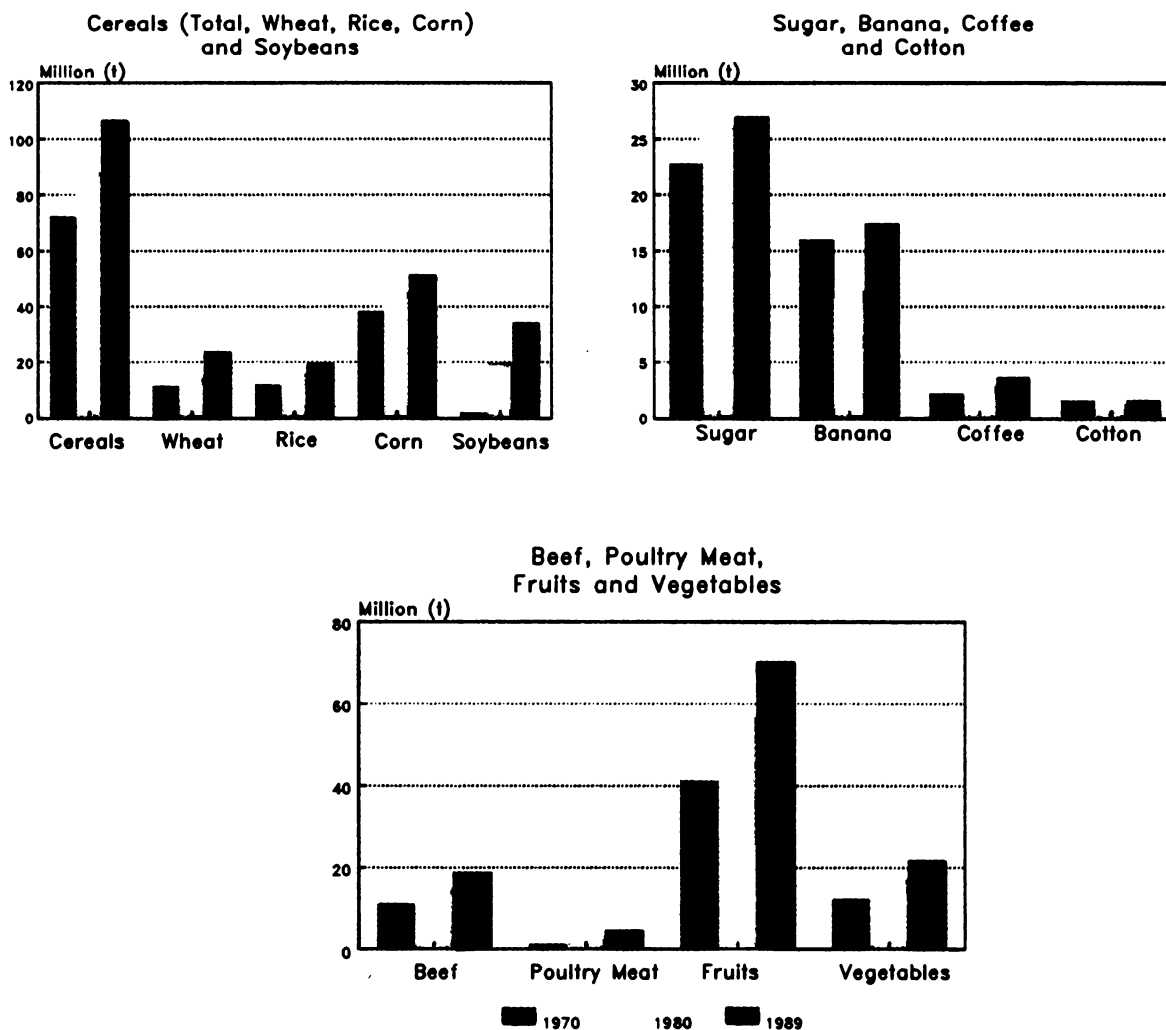

Figure 3

LAC: Area of Arable Land and Permanent Crops, Permanent Pastures and Forest Lands (Thousands of hectares and percentages)

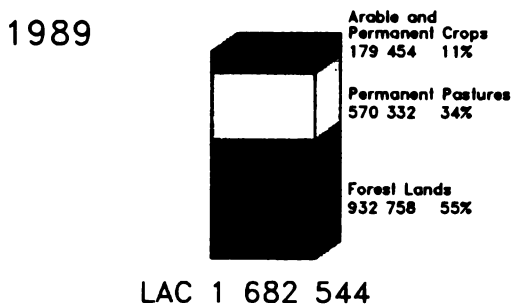
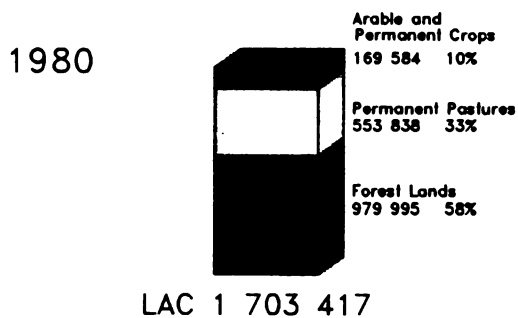

Figure 4
LAC, USA, Canada: Forested Area
(Percentages and thousands of hectares)

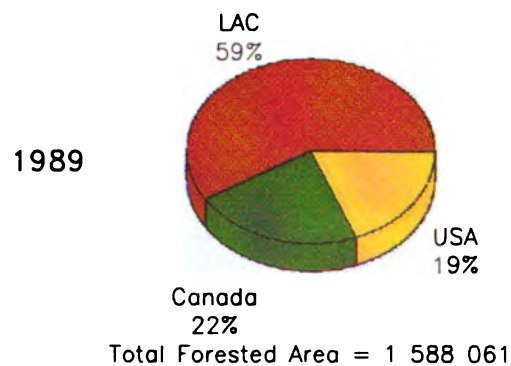
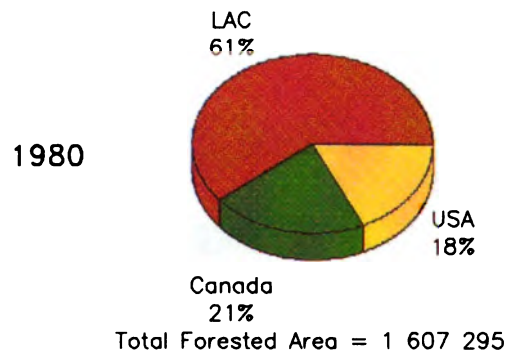
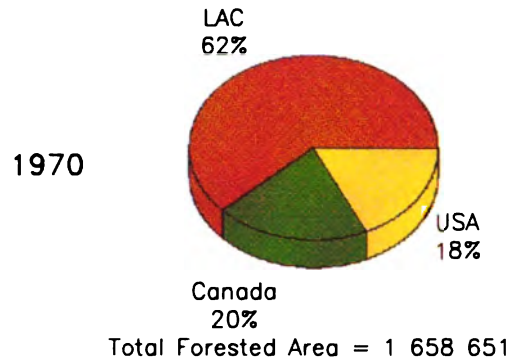
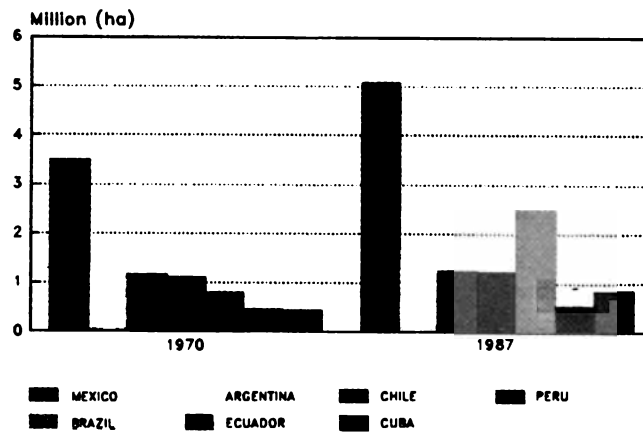

Figure 5

LAC: Area Under Irrigation (1970-1987)

Countries with more than 500 000 hectares under irrigation



Countries with less than 500 000 hectares under irrigation

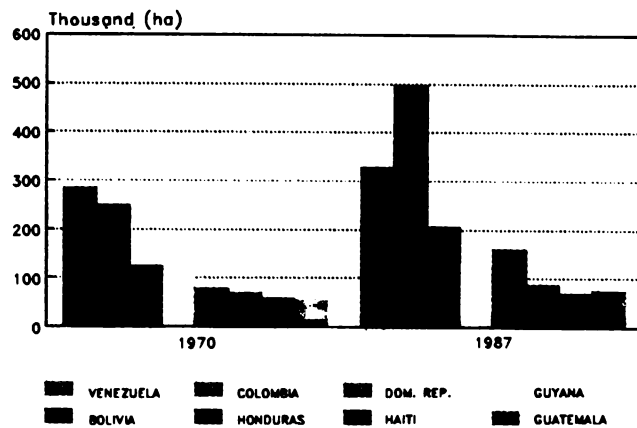

Comparison of Production by Commodity

Production of selected agricultural commodities and the distribution of production by area are compared in 1970, 1980 and 1989.

Grains-bananas and grains-vegetables. Figure 6 compares grain production with banana and vegetable production in LAC. Banana production is of minor significance when compared to that of grains. In contrast, however, vegetables increase their share of the total of grains and vegetables produced.

Bananas and vegetables. Banana and vegetable production by area (Figure 7) is evenly distributed among the Andean, Central and Southern Areas, with a share of around 30 percent in the three years under study. Vegetable production is concentrated in the Southern Area, with approximately 50 percent in each of the years; in the Andean Area it remains practically constant, while in the Central Area production rises from 23 percent in 1970 to 29 percent in 1989.

Grains-fruit and grains-coffee. Figure 8 contrasts grain production with fruit and coffee production. Grains cede first place to fruits in the consolidated total for those two groups of products; in comparing coffee with grains, the relative distribution remains constant in the years under study.

Fruit and coffee. Figure 9 shows the relative distribution of fruit and coffee production by area. The relative importance of the Southern Area in both crops is noteworthy, although its predominance in fruit production is more evident, with shares of 44, 50 and 57 percent for 1970, 1980 and 1989, respectively. The Caribbean Area's share is minor in both cases; and the relative share of the Central Area in fruit production is higher than the other areas and is surpassed in coffee production by the Andean Area. In both products the Southern Area's rising production contrasts with the downward trend in the Central and Andean Areas.

Grains-beef and grains-poultry meat. The results of assessing the contributions of beef and grains to their consolidated total production show relative stability (Figure 10). The same exercise for grains and poultry meat shows an increase in the relative weight of poultry meat, from 2 percent in 1970 to 4 percent in 1989.

Beef and poultry meat. A drop in the relative importance of beef in the total, which also includes poultry meat, may be seen (Figure 11). The share of the former in the total of both types of meat drops from 85 percent in 1970 to 69 percent in 1989. Consequently, the relative share of poultry meat rises from 15 percent in 1970 to 31 percent in 1989. The Southern Area is first in importance in regard to poultry meat, with relative shares that fluctuate between 53 and 59 percent.

Regarding beef, the decrease in the relative share of the Southern Area is offset by a relative gain in the consolidated share of the Central and Caribbean Areas.

Figure 12 show the production of beef and poultry in the four regions, revealing a considerable decline in the relative importance of the Southern Area in beef production.

Figure 6

LAC: Comparison of Production of Cereals
with Bananas and Vegetables
(Thousands of metric tons and percentages)

1970

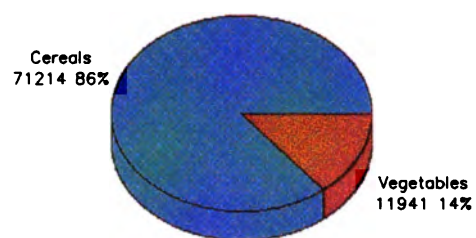
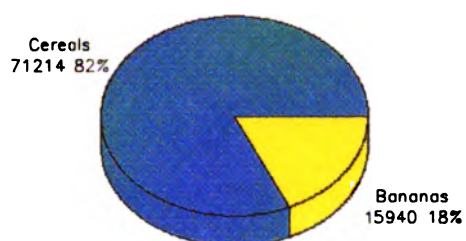

1980

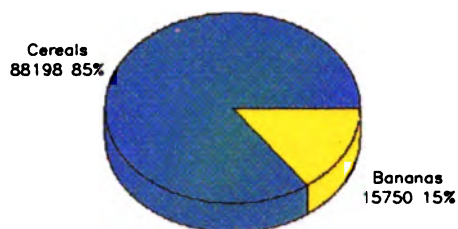

1989

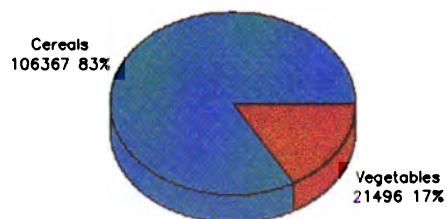
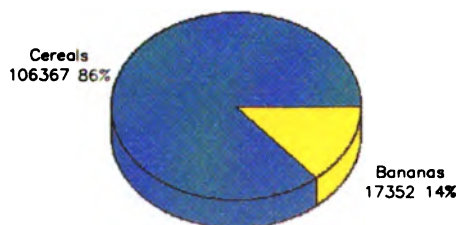

Figure 7
LAC: Production of Bananas and Vegetables
by Area in 1970, 1980 and 1989
(Percentages and thousands of metric tons)

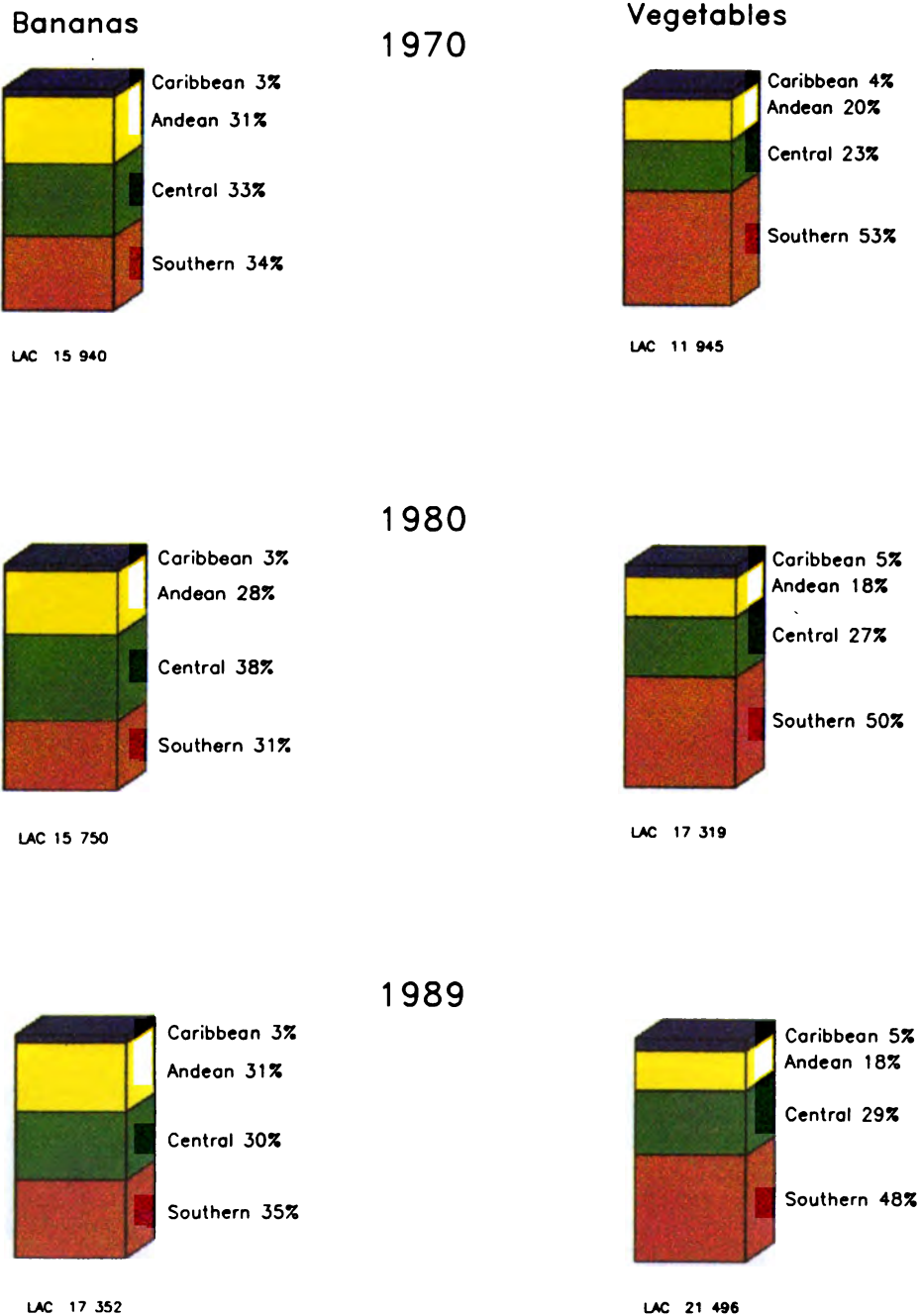
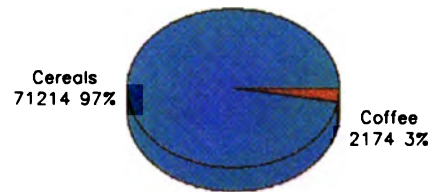
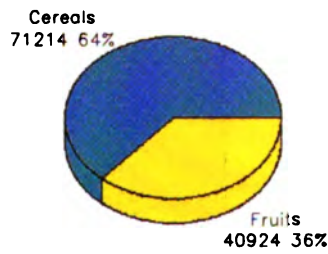

Figure 8

LAC: Comparison of Production of Cereals with Fruits and Coffee (Thousands of metric tons and percentages)

1970



1980

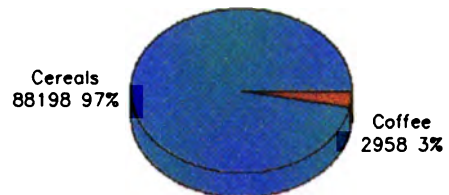
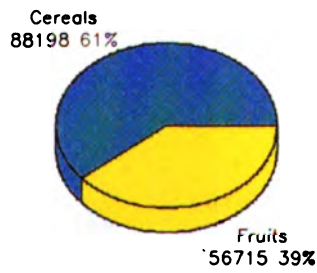

1989

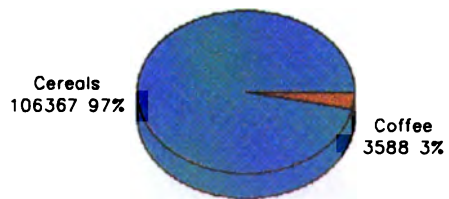
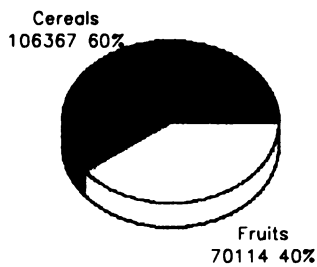

Figure 9
LAC: Production of Fruits and Coffee by
Area in 1970, 1980 and 1989
(Percentages and thousands of metric tons)

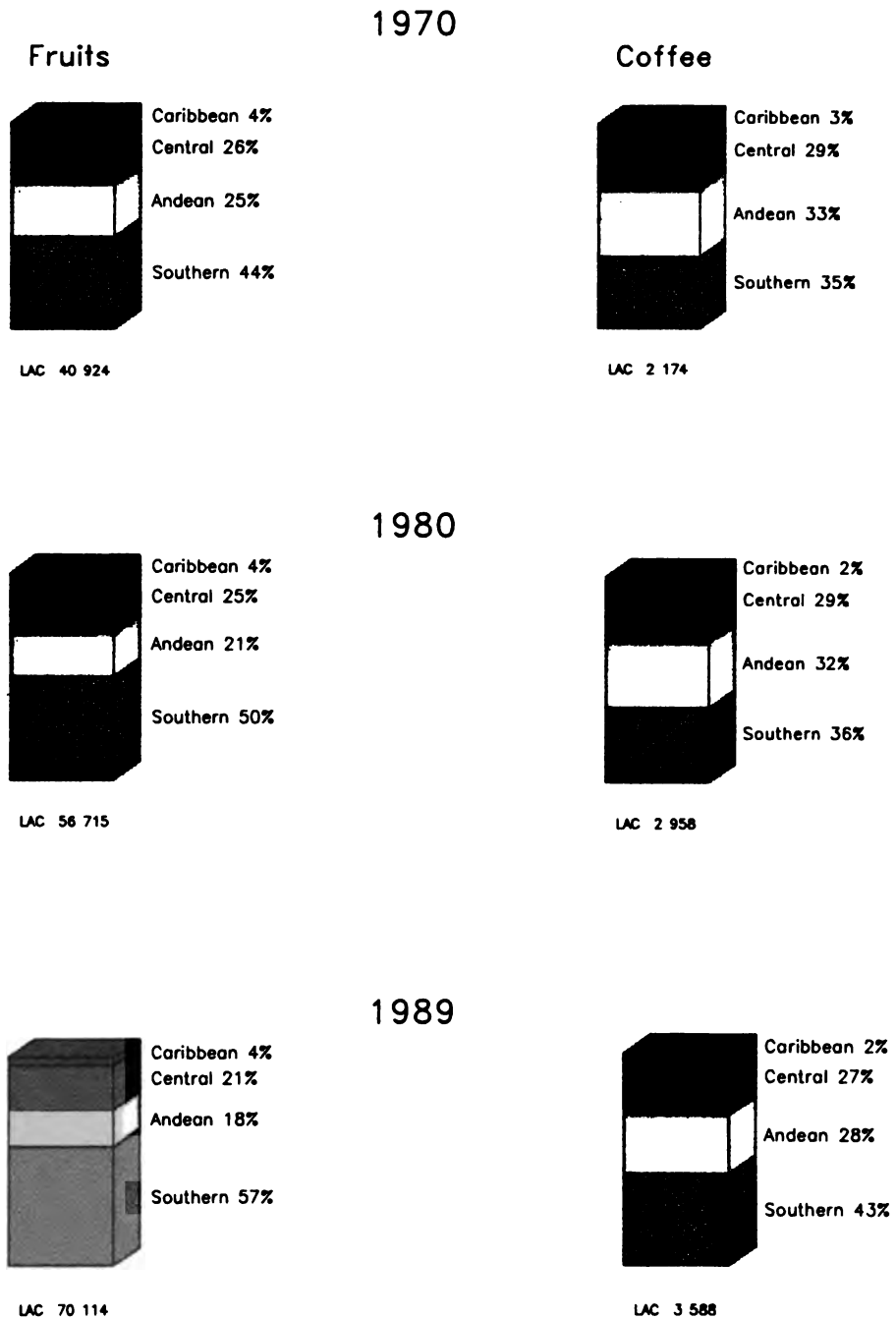
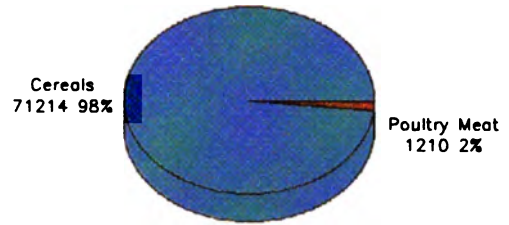
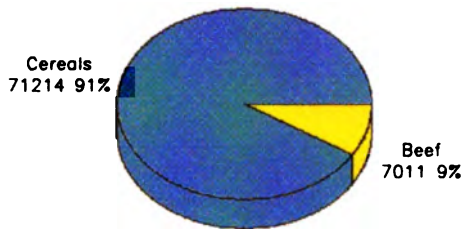

Figure 10

LAC: Comparison of Production of Cereals with Beef and Poultry Meat
(Thousands of metric tons and percentages)

1970



1980

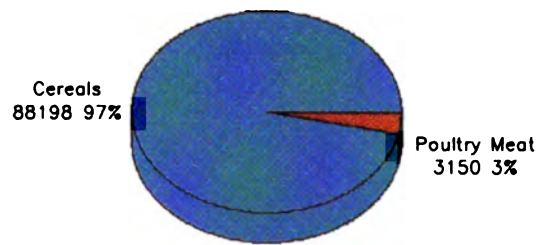
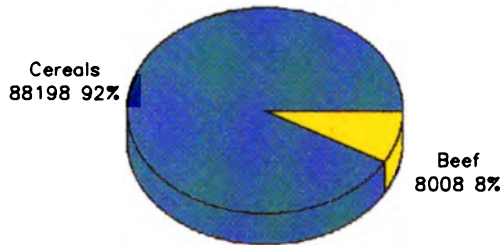

1989

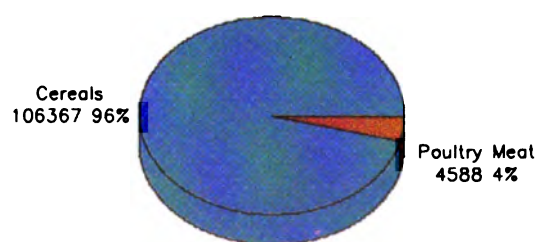
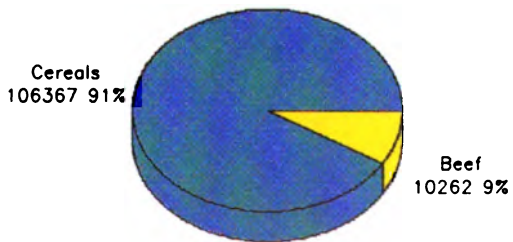

Figure 11

LAC: Volume of Production of Poultry Meat
and Beef
(Thousands of metric tons and percentages)

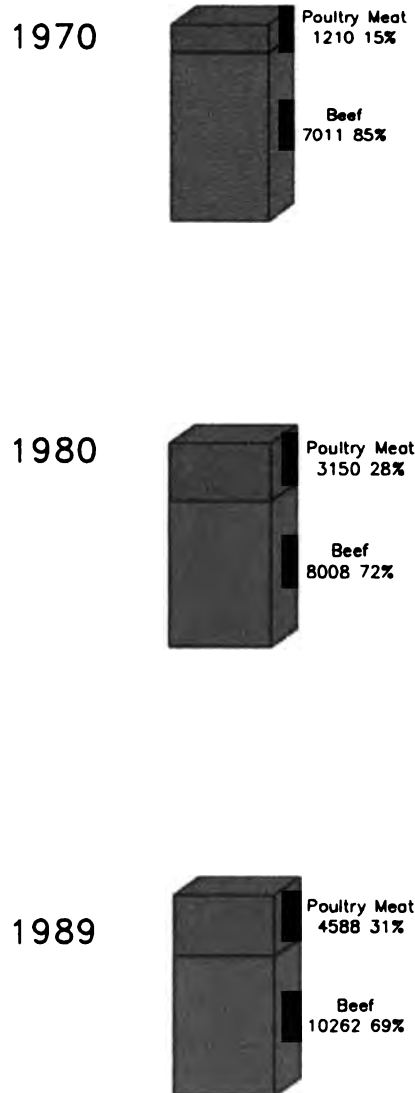
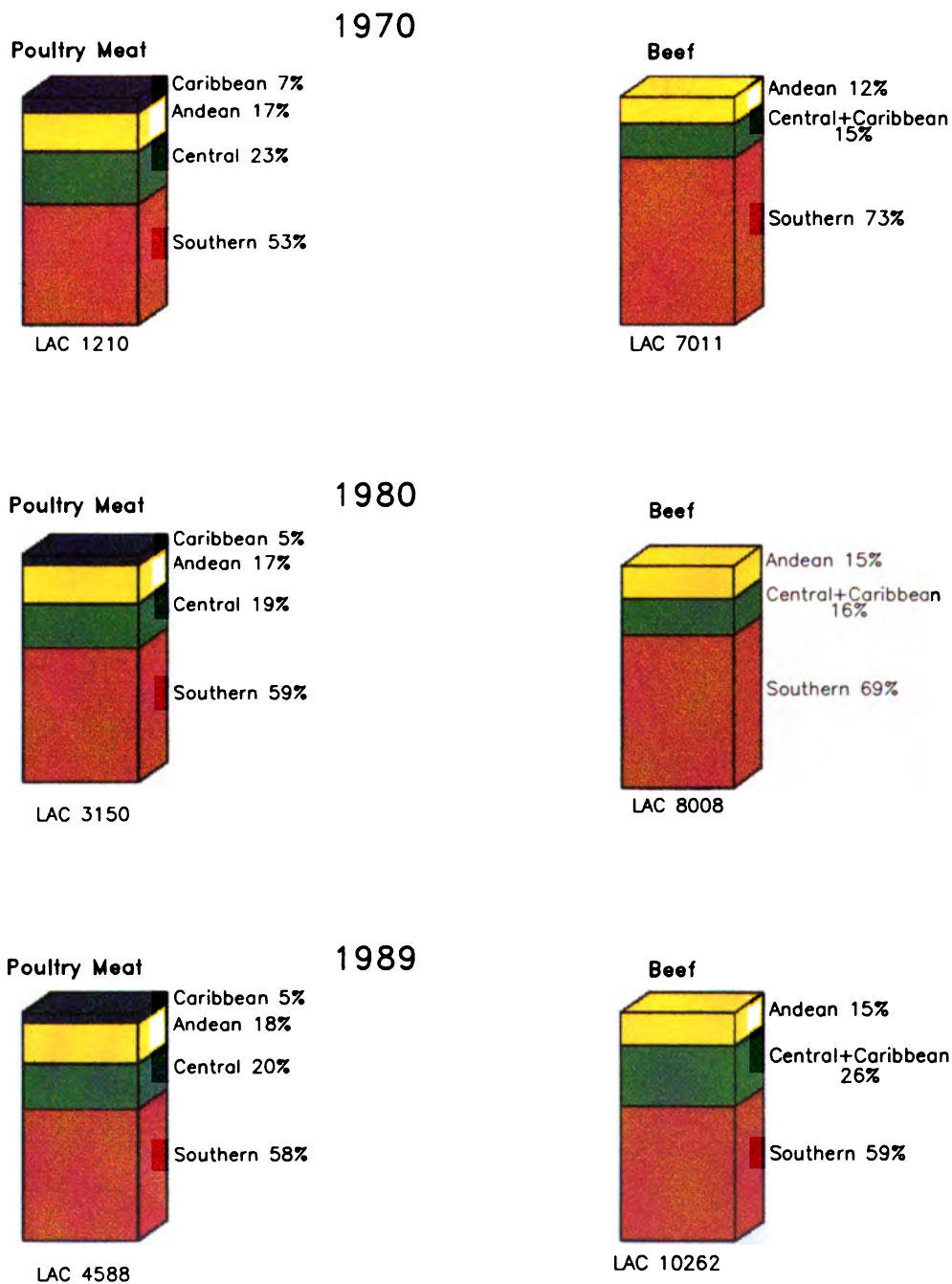

Figure 12
 LAC: Production of Beef and Poultry Meat
 by Area in 1970, 1980 and 1989
 (Thousands of metric tons and percentages)



Comparison of Production by Groups of Countries

The globalization of the economy has been accompanied by the formation of blocs of countries, the most important of which, owing to its influence in the region, is the Group of 3, consisting of Mexico, Colombia and Venezuela, and the North American Free Trade Agreement (NAFTA), made up of Canada, the United States and Mexico. In this section, the figures illustrate how production is distributed among Canada, the U.S. and LAC, the Group of 3 and the rest of LAC (excluding Mexico, Colombia and Venezuela), and between the NAFTA countries and the rest of the Americas (LAC excluding Mexico).

LAC, U.S. and Canada. Figure 13 compares grain, meat, fruit and vegetable production in Canada, the U.S. and LAC. The volumes of each of the above commodities show consistent increases, based on a comparison of the data corresponding to 1970, 1980 and 1989. With regard to fruit, the upward trend is repeated in LAC, but not in the U.S., where production rose between 1970 and 1980, but fell off in 1989 with respect to 1970. Canada's poultry, fruit and vegetable production is low in comparison with the U.S. and Latin America and the Caribbean.

LAC, NAFTA and the Group of 3. Figures 14 to 22 compare the production of selected agricultural commodities for the three periods (1970, 1980 and 1989) for the NAFTA bloc and the rest of the Americas (LAC excluding Mexico); and for the Group of 3 (Colombia, Mexico and Venezuela) and the rest of Latin America and the Caribbean.

Rice. Figure 14 shows comparative charts of rice production for the years in question. It may be seen that the NAFTA countries produce one-third of the total for the hemisphere; the Group of 3 produces between 12 and 18 percent of the total for the region.

Corn. The results for corn (Figure 15) are significantly different from those observed for rice. Production by the U.S., Mexico and Canada (NAFTA) is at least four times that of LAC, excluding Mexico, in the three years. The share of the Group of 3 fluctuates between 25 and 30 percent, which indicates the presence of major producers in the rest of LAC, among them Argentina.

Wheat. Wheat production (Figure 16) is concentrated in the NAFTA group even more so than corn; wheat production in the United States, Mexico and Canada is over seven times that of LAC, excluding Mexico. As for the Group of 3 and the rest of LAC, much the same occurs as with corn: the presence of major producers, such as Argentina, in the bloc that corresponds to the remainder of LAC places the relative shares of the Group of 3 between 19 and 24 percent.

Soybeans. As may be seen in Figure 17, there is a notable gain in soybean production in the LAC group, excluding Mexico, relative to the NAFTA group, whose percentage contribution fell off from 95 to 63 percent between 1970 and 1989. For its part, the Group of 3 experiences a sharp drop in its relative contribution from 18 to just 2 percent in 1980, rising to 3 percent in 1989, despite the fact that aggregate production

for the three countries of the group shows an increase in absolute terms from 347,000 to 1,178,000 metric tons over the past two decades.

Coffee. The countries of LAC, excluding Mexico, show a clear predominance in coffee production, which is maintained throughout the periods in question, surpassing a 90 percent share in each case (Figure 18). In the breakdown of production for LAC, the Group of 3's share is approximately one-third of the total.

Fruit. A significant share is registered by the three member countries of NAFTA (Figure 19), ranging from 36 to 43 percent of the total for the hemisphere. The Group of 3 contributes between 20 and 23 percent to the consolidated total for LAC.

Vegetables. The NAFTA bloc's share of vegetable production remains stable at around 30 percent; and in the charts comparing the Group of 3 with the rest of LAC, the former's production may be seen to be almost one-third of the total produced in LAC, showing an upward trend from 27 percent in 1970 to 34 percent in 1989 (Figure 20).

Poultry meat. Here, the predominance of the three countries of the NAFTA bloc is notable, despite experiencing a drop from 84 percent in 1970 to 74 percent in 1980, the same share reported in 1989. The share of the Group of 3 in the total for LAC dropped from 29 percent in 1970 to one-quarter of the total in the subsequent periods studied.

Beef. A high and relatively stable share of total beef production in the hemisphere is shown by NAFTA (Figure 22), exceeding 60 percent in every case. In LAC, consistent growth in the share of the Group of 3 may be noted, doubling from 16 percent in 1970 to 23 percent in 1989.

Figure 13
 LAC, USA, Canada: Volume of Production of
 Commodities in 1970, 1980 and 1989
 (Millions of metric tons)

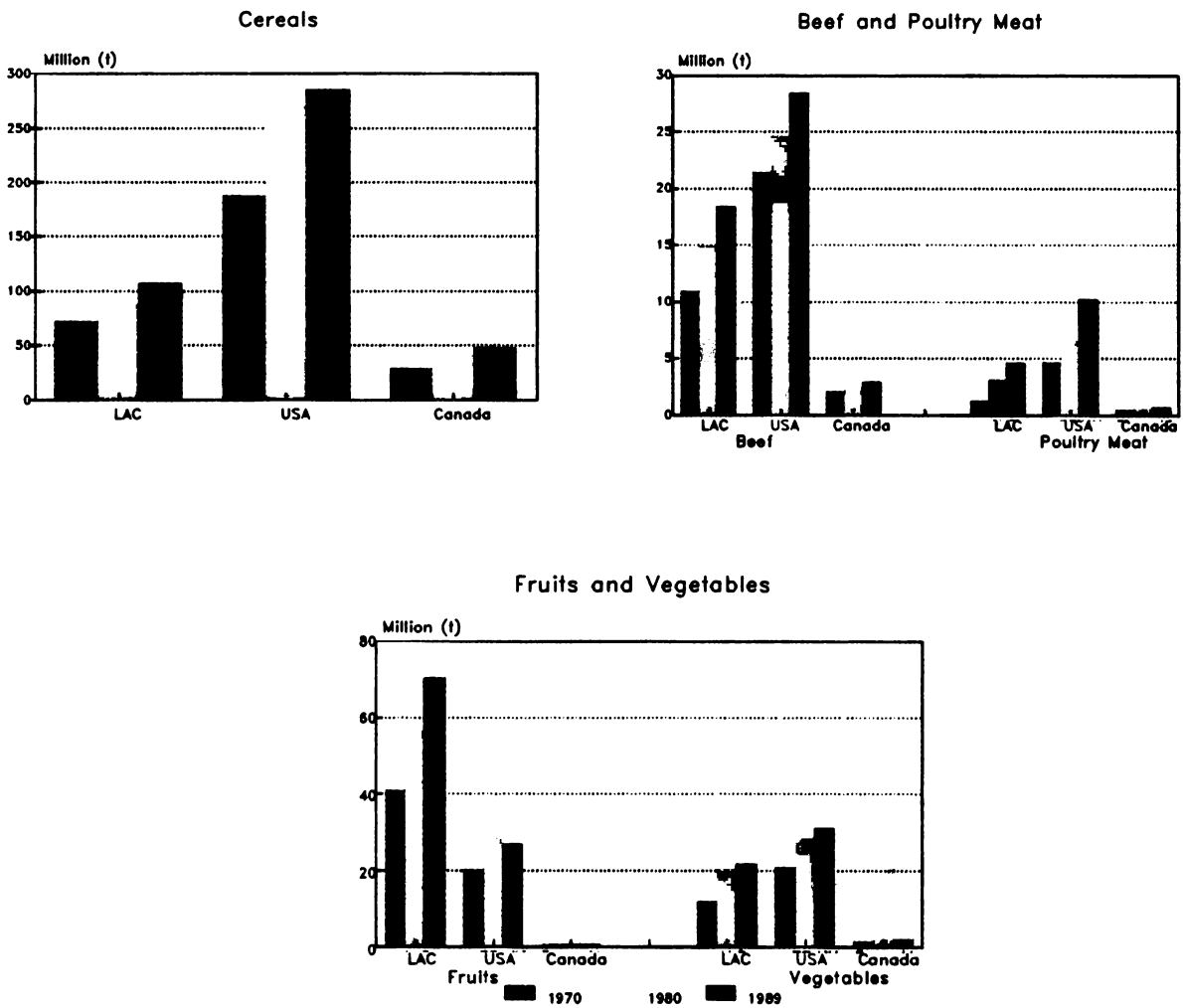
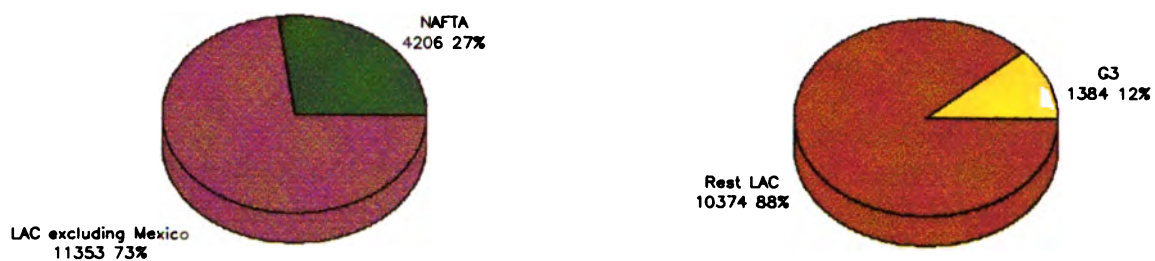
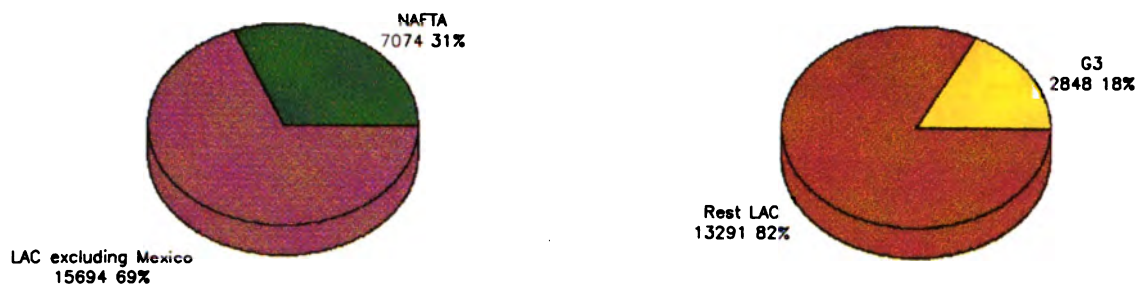

Figure 14
LAC, Group of 3, NAFTA: Volume of Production of Rice
in 1970, 1980 and 1989
(Thousands of metric tons and percentages)

1970



1980



1989

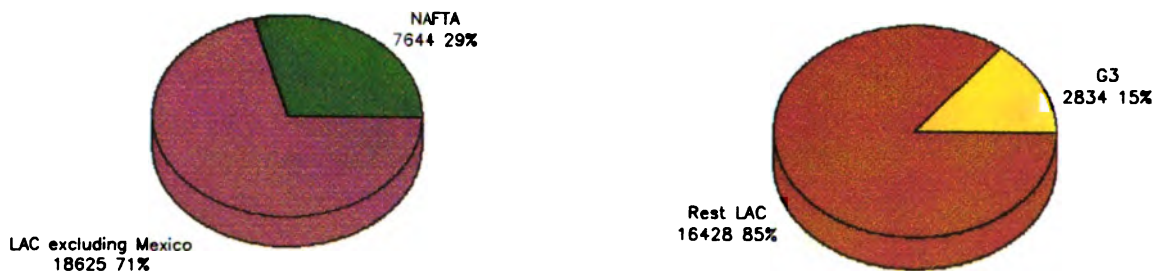

NAFTA: Canada, United States of America and Mexico

Group of 3 (G3): Mexico, Colombia and Venezuela

Figure 15
 LAC, Group of 3, NAFTA: Volume of Production of Corn
 in 1970, 1980 and 1989
 (Thousands of metric tons and percentages)

1970



1980

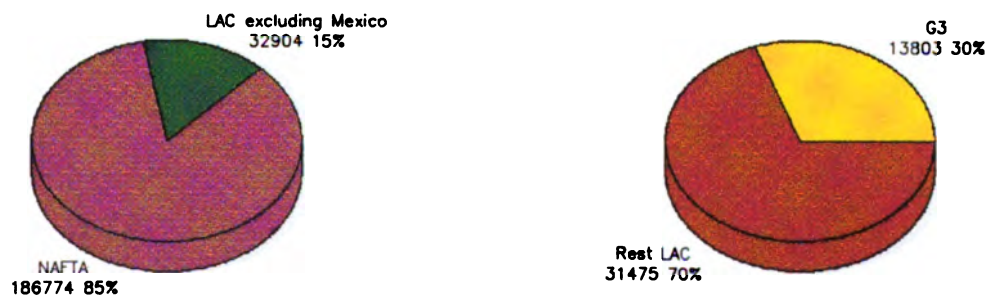

1989

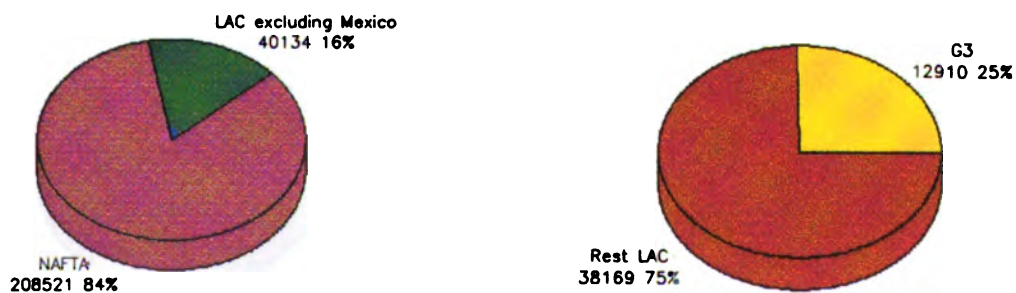

NAFTA: Canada, United States of America and Mexico
 Group of 3 (G3): Mexico, Colombia and Venezuela

Figure 16
 LAC, Group of 3, NAFTA: Volume of Production of Wheat
 in 1970, 1980 and 1989
 (Thousands of metric tons and percentages)

1970

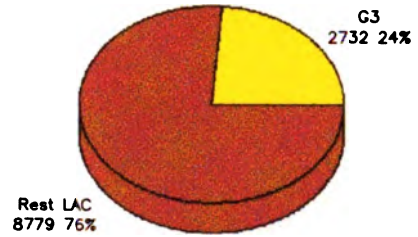
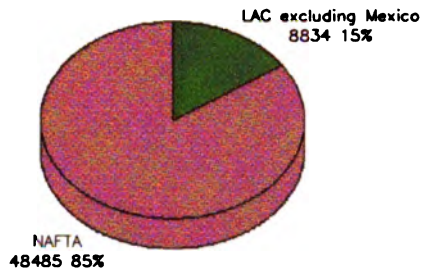

1980

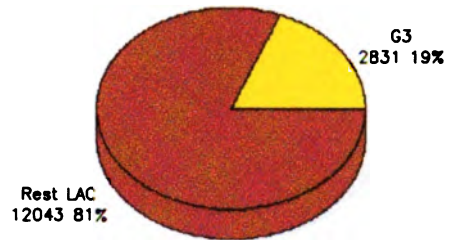
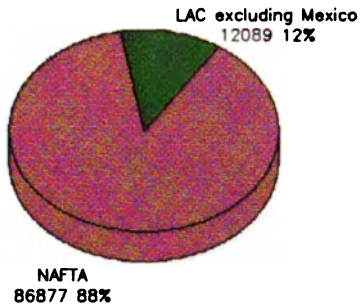

1989

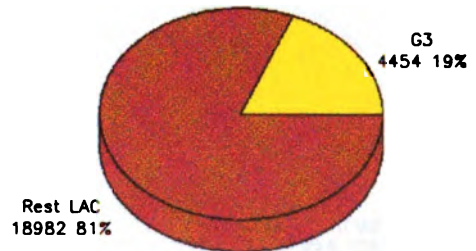
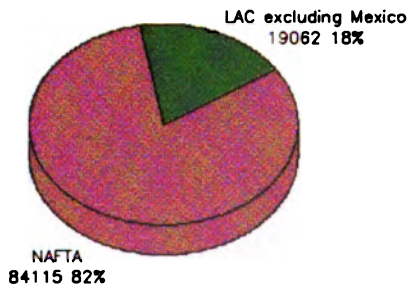

NAFTA: Canada, United States of America and Mexico
 Group of 3 (G3): Mexico, Colombia and Venezuela

Figure 17
 LAC, Group of 3, NAFTA: Volume of Production of Soybeans in
 1970, 1980 and 1989
 (Thousands of metric tons and percentages)

1970

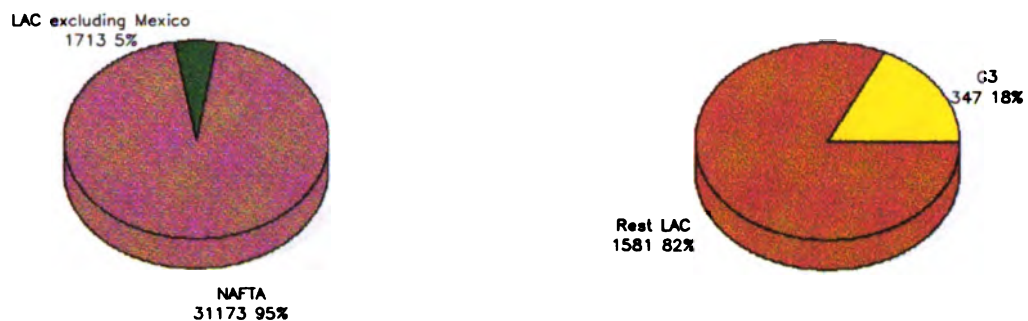

1980

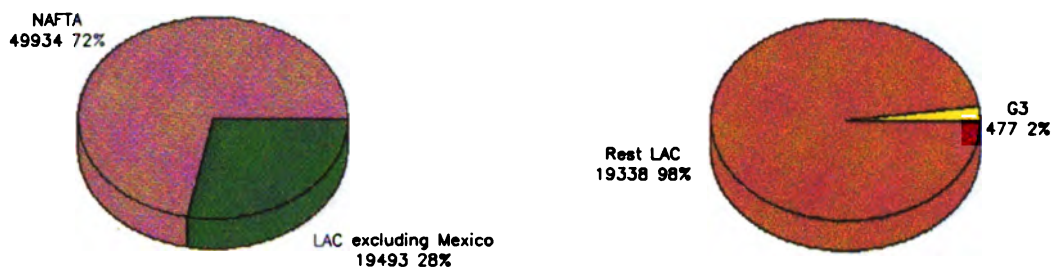

1989

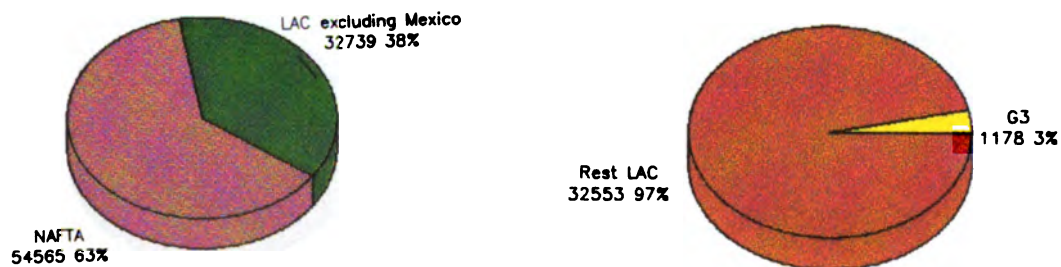

NAFTA: Canada, United States of America and Mexico
 Group of 3 (G3): Mexico, Colombia and Venezuela

Figure 18
 LAC, Group of 3, NAFTA: Volume of Production of Coffee in
 1970, 1980 and 1989
 (Thousands of metric tons and percentages)

1970

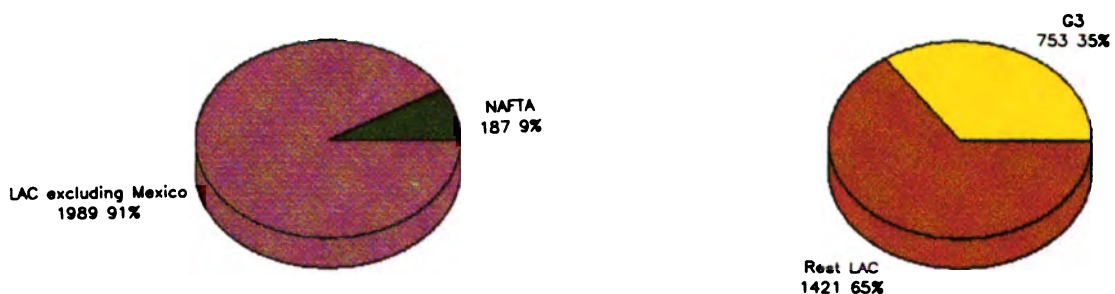

1980

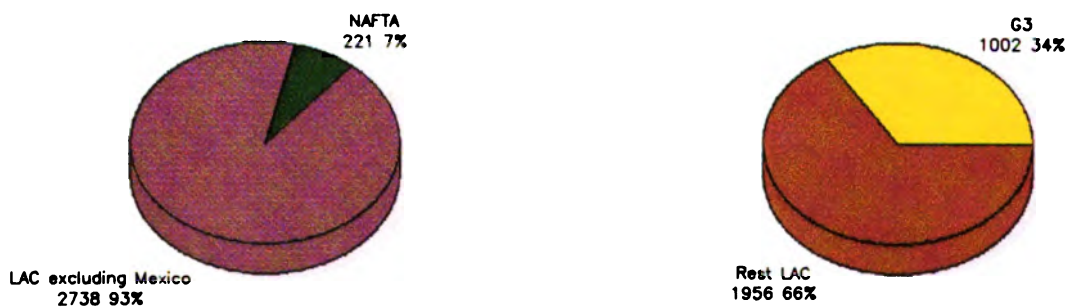

1989



NAFTA: Canada, United States of America and Mexico
 Group of 3 (G3): Mexico, Colombia and Venezuela

Figure 19
LAC, Group of 3, NAFTA: Volume of Production of Fruits in
1970, 1980 and 1989
(Thousands of metric tons and percentages)

1970

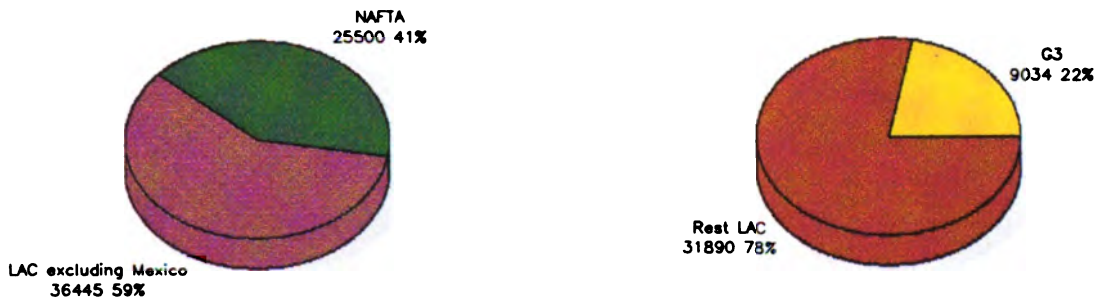

1980

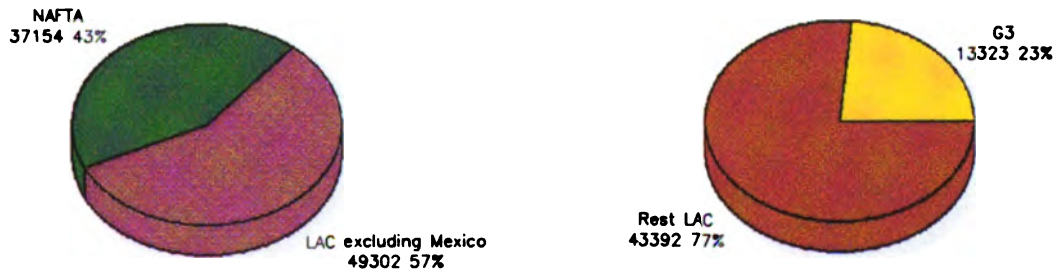

1989

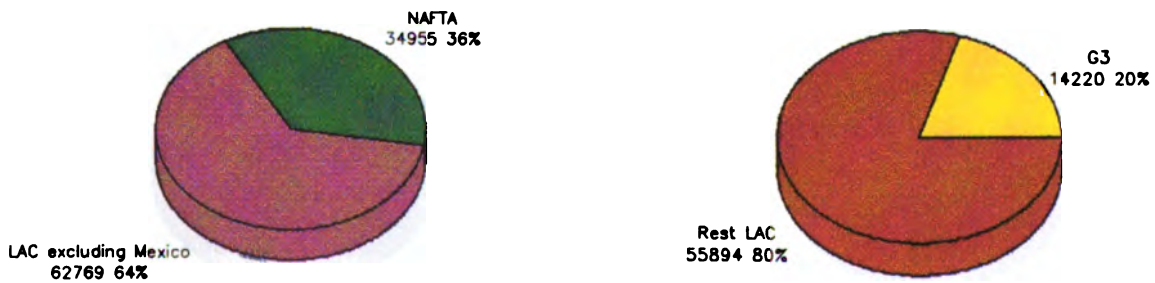

NAFTA: Canada, United States of America and Mexico
Group of 3 (G3): Mexico, Colombia and Venezuela

Figure 20
LAC, Group of 3, NAFTA: Volume of Production of Vegetables
in 1970, 1980 and 1989
(Thousands of metric tons and percentages)

1970

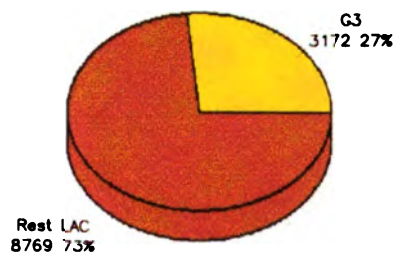
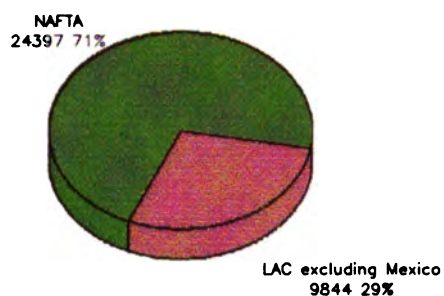

1980

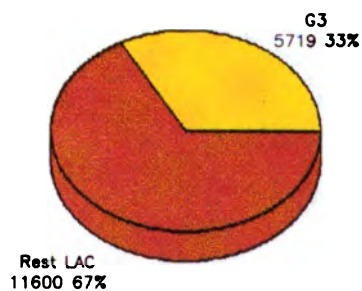
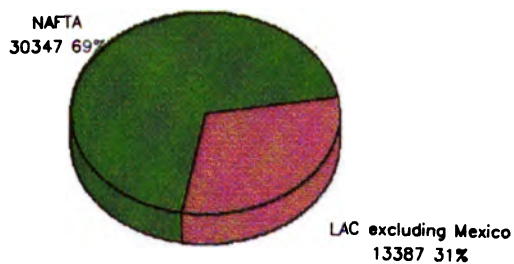

1989

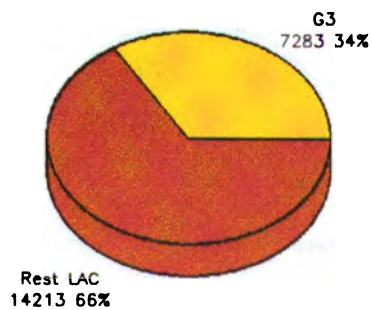
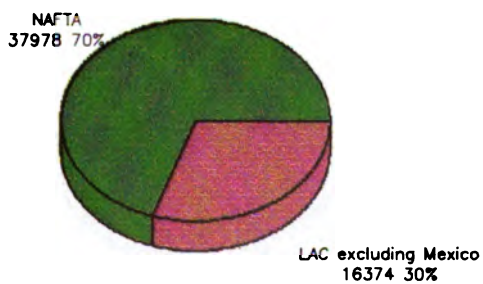

NAFTA: Canada, United States of America and Mexico
Group of 3 (G3): Mexico, Colombia and Venezuela

Figure 21
 LAC, Group of 3, NAFTA: Volume of Production of Poultry Meat
 in 1970, 1980 and 1989
 (Thousands of metric tons and percentages)

1970

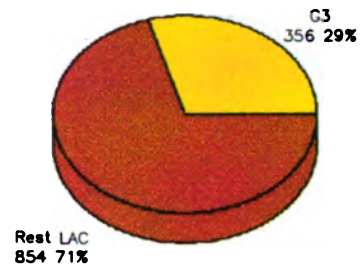
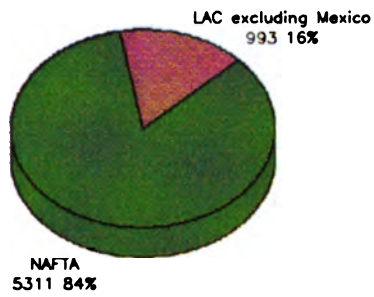

1980

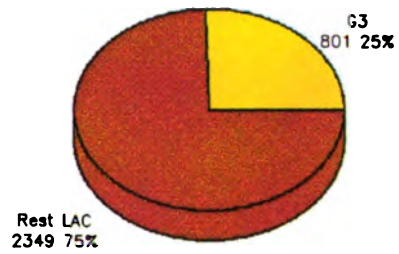
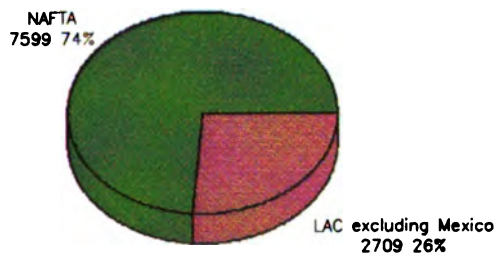

1989

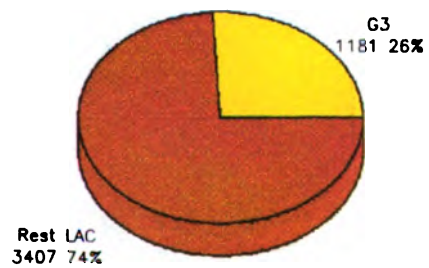
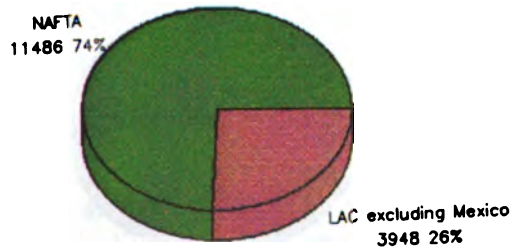

NAFTA: Canada, United States of America and Mexico
 Group of 3 (G3): Mexico, Colombia and Venezuela

Figure 22
LAC, Group of 3, NAFTA: Volume of Production of Beef in
1970, 1980 and 1989
(Thousands of metric tons and percentages)

1970

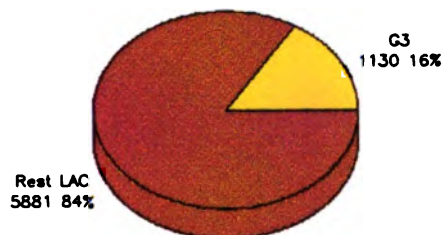
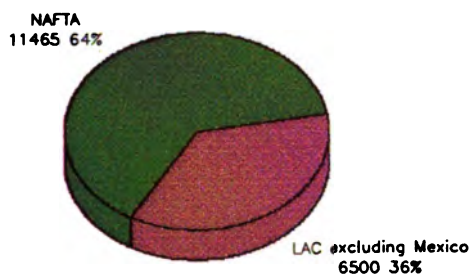

1980

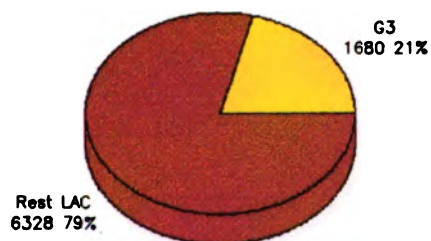
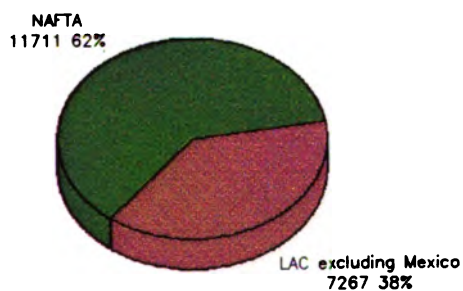

1989

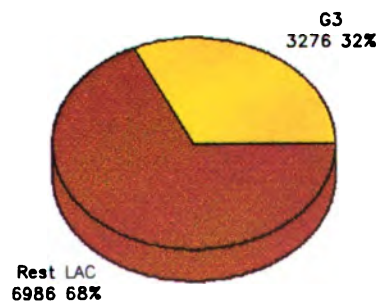
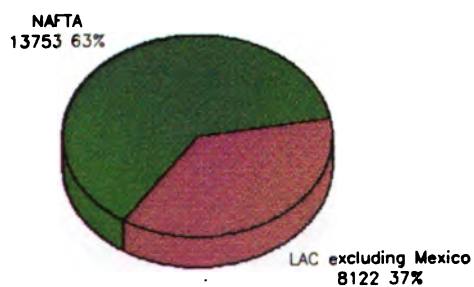

NAFTA: Canada, United States of America and Mexico
Group of 3 (G3): Mexico, Colombia and Venezuela

CHANGES IN PRODUCTIVITY AND USE OF FACTORS

Yield of Basic Commodities

Changes in agricultural production generally occur as a result of variations in the area allotted to a crop or in the number of animals, depending on whether the activity in question is agriculture or livestock-raising, as well as from variations in physical productivity or yields. Bearing in mind chart analyses of production, this section shows productivity in 1970 and in 1989 for the countries of LAC; to that end, we have used minimum, maximum and median values, as well as standard deviation as a measure of the yield spread.

Figure 23 shows productivity ranges for grains and soybeans. Average grain productivity rises, rice yields increase from 2.4 t/ha to 3.3 t/ha, wheat productivity goes from 1.1 t/ha to 1.7 t/ha and the average yield for corn rises from 1.5 t/ha to 1.9 t/ha. Soybean productivity increases and the relative yield spread is reduced, from 1.3 t/ha with a standard deviation of 0.36 t/ha, to 1.7 t/ha with a standard deviation of 0.21.

The yield ranges of selected agricultural products are complemented with data relative to coffee, bananas, milk and eggs (Figure 24). A slight increase in average coffee productivity may be observed, with a relative spread that varies only slightly when compared with the yields for 1970 and 1989. As for bananas, there are wide ranges with the greatest relative yield spreads, with productivity ranging between 2 t/ha and 45 t/ha in 1970 and between 1.5 t/ha and 57 t/ha in 1989, while the regional average shows a slight increase. In milk, an increase in average regional productivity can be seen, from 1.2 t/animal to 1.4 t/animal, whereas the minimum tends to remain constant and the maximum increases from 4.1 t/animal to 6.1 t/animal. Egg productivity increases on average from 7.5 kg/animal to 8.5 kg/animal, with a widening of the productivity range, which, although maintaining a minimum of 3 kg/animal, experiences an increase in the maximum from 13 kg/animal to 16 kg/animal.

Utilization of Factors of Production

Indicators of the ratios in the use of factors of production have been generated, using as a reference the unit of area, the labor/land and capital/land ratios. In the case of the latter, special consideration was given to the number of tractors per unit of area and the quantity of fertilizer per unit of area. The median for the region has been established, that is to say, the ranges between which these coefficients vary in terms of national data averages and statistical measures: the arithmetical mean and the standard deviation for 1970 and 1989.

As may be seen in Figure 25, the mean ratio of number of tractors per thousand hectares is 7.4, the minimum being 1 and the maximum 21 tractors in 1970; in 1989, however, the minimum value remains the same, the average rises to 9.1 and the maximum to 25 tractors per thousand hectares. With regard to the labor/land ratio, a reduction in the average number of workers per unit of land may be observed, as well as a drop in the maximum value, from 0.48 workers per thousand hectares in 1970, to 0.45 workers per thousand hectares in 1989.

As regards the use of farm workers per hectare, the range in 1970 is from 0.1 to 2.3, with an average of 0.48; in 1989 the maximum value drops to two workers per hectare and the average value goes down to 0.45. As to the use of fertilizers, the maximum value in the range goes from 125 kg/ha in 1970, to almost 200 kg/ha in 1989; and the average from 48 kg/ha to 66 kg/ha; average use of fertilizers rose from 48 kg/ha to 66 kg per hectare.

Figure 23

LAC: Ranges of Productivity of Cereals and Soybeans
in 1970 and 1989 (Minimum, median and maximum values)

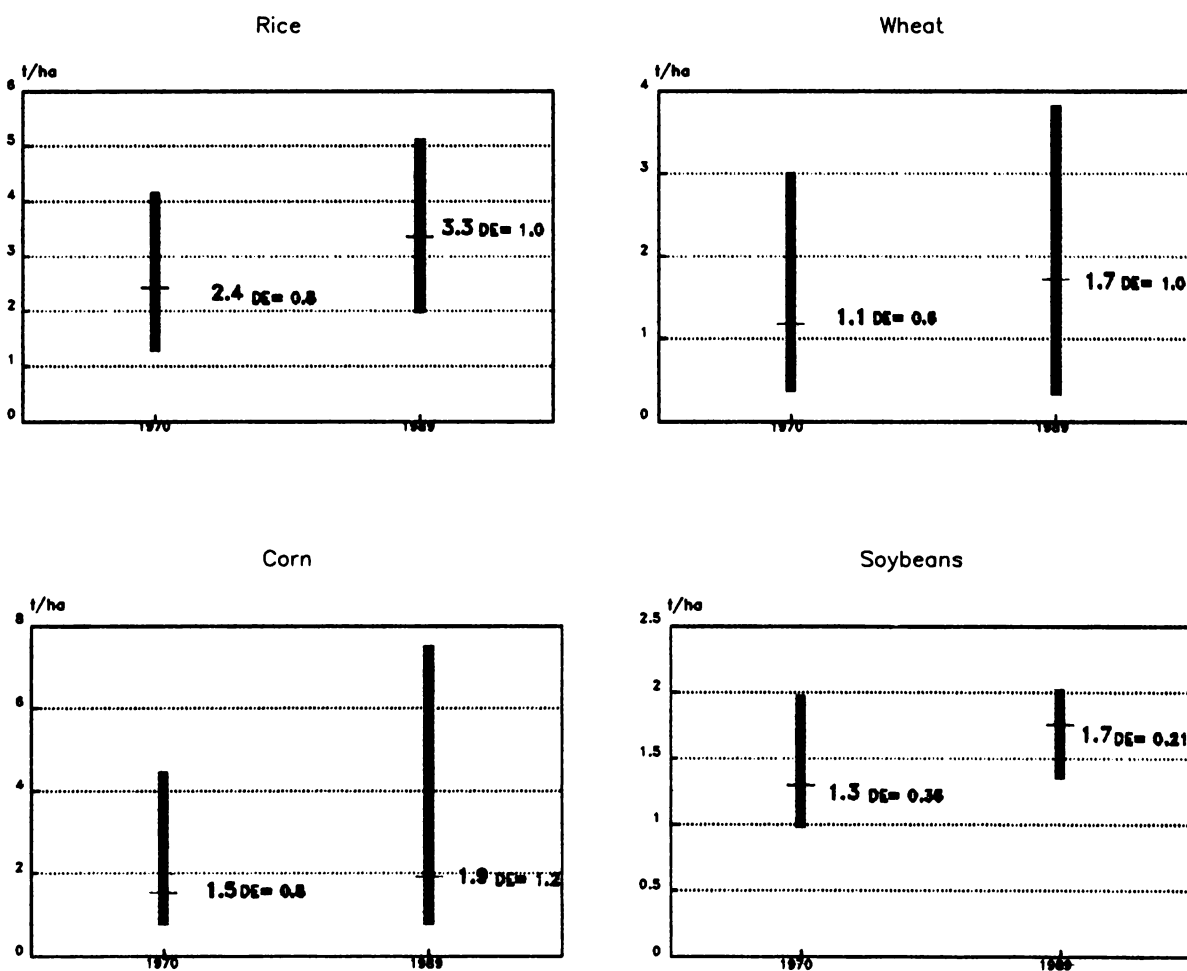

DE (SD) = Standard Deviation

Figure 24

LAC: Ranges of Productivity of Coffee, Milk, Bananas and Eggs in 1970 and 1989 (Minimum, median and maximum values)

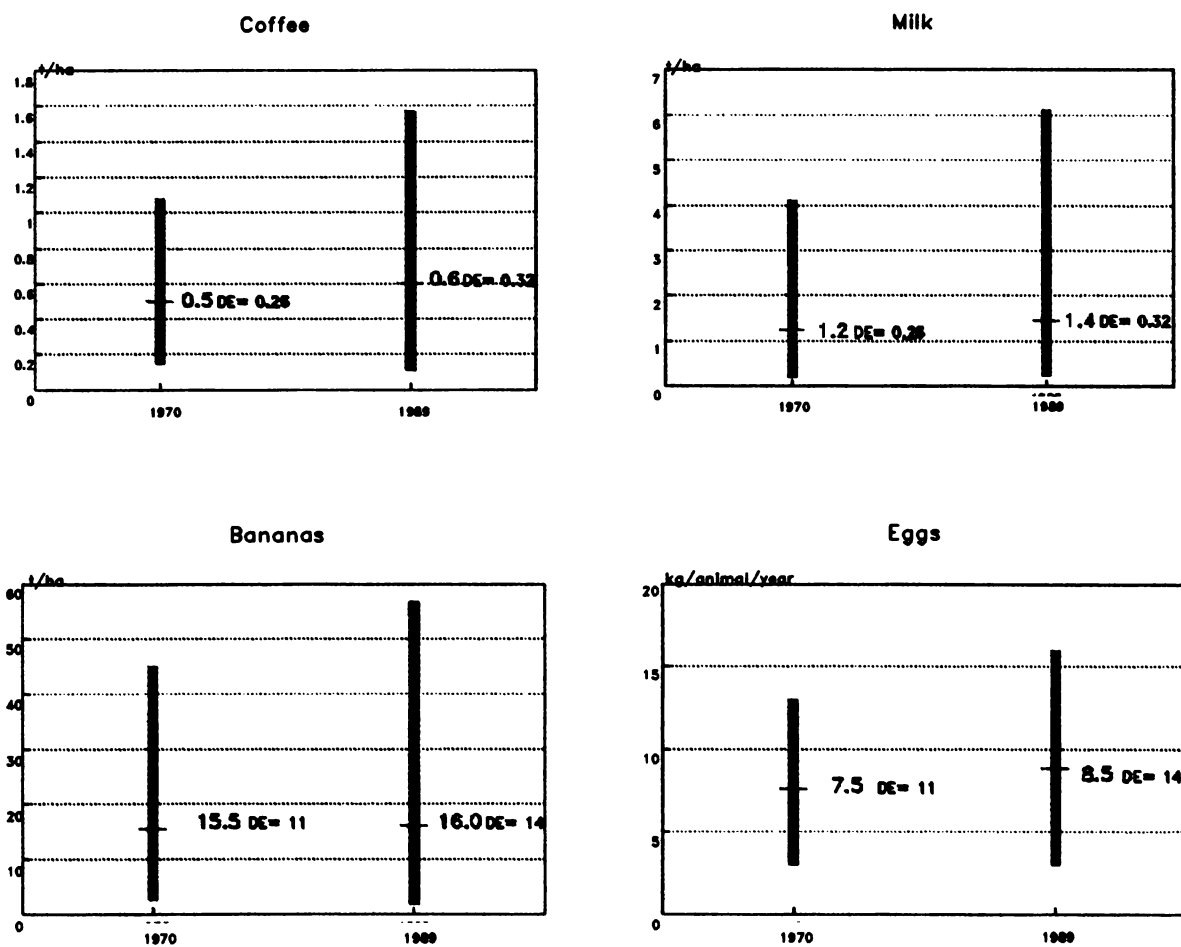

DE (SD) = Standard Deviation

Figure 25

LAC: Ranges of Utilization of Inputs in
1970 and 1987 (Minimum, median and maximum values)

Tractors

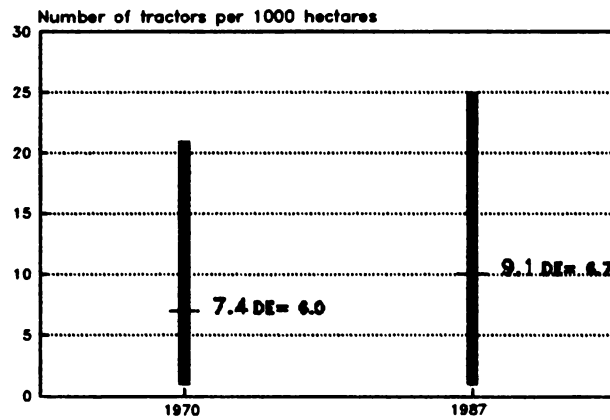

Agricultural Workers

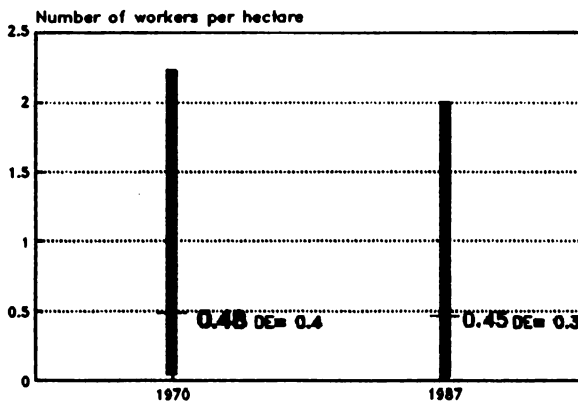

Fertilizers

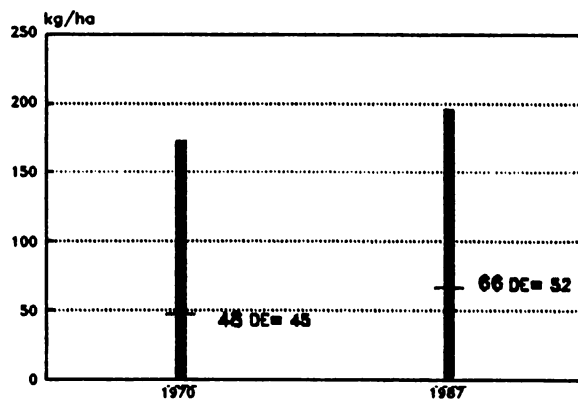

DE (SD) = Standard Deviation

AGRICULTURAL AND OVERALL TRADE

Total Agricultural Exports and Exports by Groups of Products

The value of agricultural exports from LAC grew consistently during the 1970s, reaching a high point in 1980. From that time on, exports experienced downturns and recoveries, without surpassing the levels achieved in 1980 until 1989 (see Figure 26, chart on top left).

The relative share of agricultural exports in total exports shows a decrease over the past twenty years (Figure 27). This result reflects the trend experienced in this regard by agricultural exports in the Central and Southern Areas, which is offset by the performance observed in the rest of the region. In the Caribbean Area, there is an increasingly heavy dependence on agricultural exports. In the Andean Area, the share of agricultural exports in total exports is significantly lower than in the other areas, but there is no evidence of a consistent trend in any direction. In general, such performance may be associated with the increased diversification of Southern and Central Area exports.

In order to carry out an in-depth study of the changes that have occurred in agricultural trade, a group of products made up of cotton, sugar, bananas, coffee, grains, meat products, tobacco, and vegetables, fruits and nuts was selected. Coffee and sugar are prominent in this group owing to their important share in the total value of exports, with the peculiarity that coffee is exported in similar proportions from three areas (Southern, Andean and Central), and that sugar exports are concentrated in the Caribbean Area. Banana and tobacco exports are rising. Exports of grains, coffee and meat show fluctuations. Trade in cotton grew significantly, fell off sharply and made a partial recovery in recent years. The export value of the subgroup made up of vegetables, fruits and nuts (chart, Figure 26) shows an upward trend throughout the period in question.

The structure of consolidated exports by area for the group of selected products shows the Southern Area with a majority proportion of the total exported, relatively equal shares for the Caribbean and Central Areas and the lowest figures registered are for the Andean Area (Figure 26). The largest contributions to the Southern Area's export value come from coffee, grains and meat. In the Andean Area, the share of coffee is notable, followed by bananas. The most important shares of total exports for the group of selected products in the Central Area correspond to coffee, bananas and sugar. In the Caribbean Area, sugar accounts for a major proportion of total exports for the products selected, which explains the significant share of the Caribbean Area in the total by area (Figure 26, chart on top right).

The paragraphs below contain comments on the performance of exports for each of the products or subgroups, considered individually, during the period from 1970 to 1989.

Cotton. The value of the cotton exported by LAC grew rapidly throughout the 1970s, followed by an equally rapid downturn, replicating the general export patterns of the Central Area, whose relative weight in the regional export market is considerable. This performance can be explained by the reversal of the upward trend in Guatemalan, Mexican and Salvadoran exports towards the end of that decade, reinforced by the drop in Nicaraguan exports as of 1984. In recent years, the Southern Area increased its share in both absolute and relative terms, occupying first place as result of its contribution to overall exports (Figure 28, chart on bottom left).

During the period in question, exports from the Central Area reached an average relative share of 53.3 percent, which, coupled with the contribution from the Southern Area, represents almost 85 percent of the total exported.

The maximum value of LAC's exports during the period was reached in 1978. Thereafter, the region's exports not only fell off in absolute terms, but also lost their relative weight in the world cotton trade.

Sugar. The export value of sugar underwent rapid growth from 1970 to 1975, then suffered a setback, followed by an upturn, reaching the highest level registered during the period in 1980, when exports totalled more than US\$7.3 billion. As of 1980, sugar exports showed a downward trend, with fluctuations. The predominance of the Caribbean Area in this market is notable (Figure 29, chart on bottom right).

Bananas. Banana exports reflect growth, with few exceptions, throughout the past two decades, increasing from US\$340 million in 1970 to more than US\$1.5 billion in 1989 (Figure 29, chart on top right).

Two Central Area countries (Honduras and Costa Rica) and two in the Andean Area (Ecuador and Colombia) account for around 80 percent of the total export value. Those two areas, including all their member countries, average a 96.1 percent share of total exports. The two remaining areas show an exiguous overall contribution, despite the fact that one of those areas includes Brazil, one of the major banana producers.

Coffee. The export value of coffee reflects irregular performance, with a significant upturn in the second half of the 1970s, subsequently falling off and resuming its upward trend, reaching the highest value for the period in 1986 (Figure 29, chart on bottom left).

Market distribution by areas shows a balance among the Southern, Andean and Central Areas, each with just over 30 percent, and an insignificant share by the Caribbean Area.

Meat. The concentration of exports of meat products in only a few countries, and the cyclical performance of their value, characterize trade in these products over the past two decades (Figure 29, chart on top left). The years 1973, 1980 and 1987 stand as the three high points of the crests observed in the patterns of overall meat exports. This performance is basically a reflection of the value of the Southern Area's exports.

Grains. Grain exports experience irregular performance characterized by fluctuations and are dominated by the Southern Area, with more than 96 percent of the total exported during the last twenty years (Figure 28, chart on top right).

Tobacco. Tobacco presents the lowest contribution to total exports of the commodities selected. The export value of tobacco shows a general upward trend which dips after the high point reached in 1981 and recovers towards the end of the 1980s. The Southern Area accounts for an average of 62 percent of the total exported. The shares of the Central and Caribbean Areas in total tobacco exports average 16.6 and 16.1 percent, respectively (Figure 28, chart on top left).

Vegetables, fruits and nuts. The export value of this group of products, which includes bananas, shows a clear upward trend (Figures 28 and 29), with a notable fall-off during the period from 1981-1983, when the exports of the two main exporting areas experienced simultaneous reductions. The Southern and Central Areas account for an average of 77 percent of overall regional exports for this group of products.

Dominant Exporting Countries by Selected Commodities

Cotton. Brazil, Paraguay, Nicaragua and Guatemala stand out because of the magnitude of their contribution to overall export value (Figure 30). This is a market in which, as a rule, the performance of the countries' exports is erratic. Brazil, one of the major exporters, registered very low exports in 1976, dropping even lower in 1979, and subsequently recovering with marked fluctuations. Paraguay showed an upward trend in its cotton exports until 1981, after which they continued rising, but irregularly. Brazil was the leading country in exports in 1970, Mexico in 1980 and Paraguay in 1989.

Sugar. The predominance of Cuba and Brazil in LAC's sugar exports is clear (Figure 31). The performance of these two nation's exports is differentiated by contrasting trends in their market share, measured in the years 1970, 1980 and 1989. Whereas Cuba's contribution to regional exports tends to increase, Brazil's is reduced. These countries, which figure among the world's top sugar exporters, account for between 60 and 89 percent of the region's total exports during the last two decades.

Bananas. The predominant countries in banana exports are Honduras and Costa Rica in the Central Area and Ecuador and Colombia in the Andean Area. These countries account for around 80 percent of the total export value. Panama's relative share decreased, while Colombia's percentage share increased (Figure 31).

Coffee. Brazil and Colombia alternate in first and second places as coffee exporters and account for an average of 61 percent of overall coffee exports. Mexico, El Salvador and Guatemala, with similar shares among themselves, along with Colombia and Brazil, account for more than 80 percent of total exports (Figure 32).

Figure 26

LAC: Agricultural Exports – Total and for Selected Products in 1970–1988

LAC: Value of Agricultural Exports – Total and for Selected Products (1970–1988)

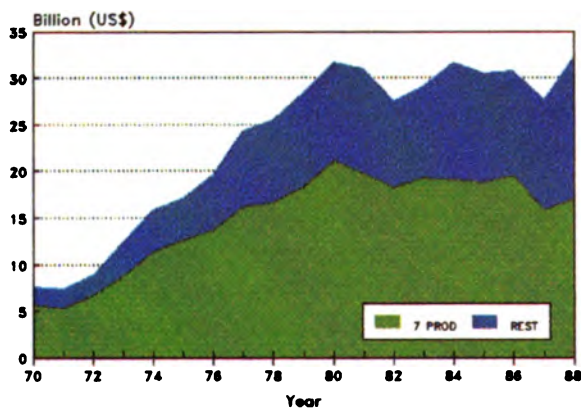

LAC: Value of Exports of Group of Seven Selected Products by Area (1970 – 1989)

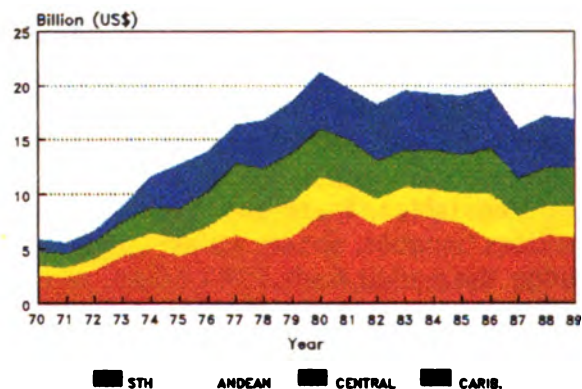

LAC: Percentage Ratio between the Exported Value of the Group of Seven Products and Agricultural Exported Value (1970–1988)

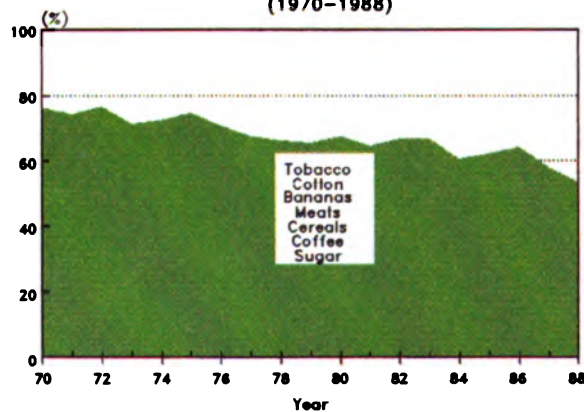

LAC: Value of Exports of Vegetables, Fruits and Nuts (1970–1989)

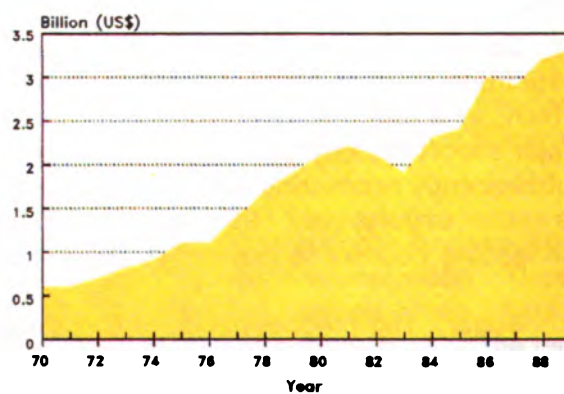

LAC: Value of Exports of Group of Seven Selected Products (1970–1988)

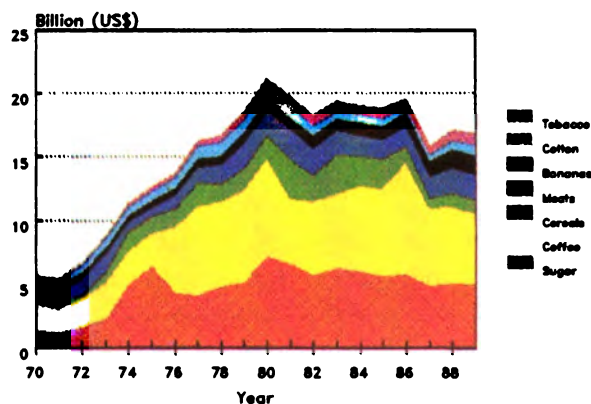

- List of Selected Products
- Group of Seven Products
 - Tobacco and its products
 - Cotton (fiber)
 - Bananas
 - Meat Products
 - Cereals
 - Coffee (all grades)
 - Centrifugal Sugar
 - Subgroup of vegetables, fruits and nuts

Figure 27

LAC: Agricultural Exports as a Proportion of Total Exports (1970–1988)

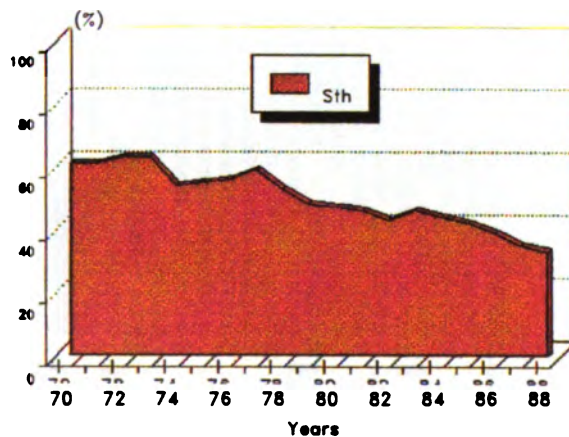
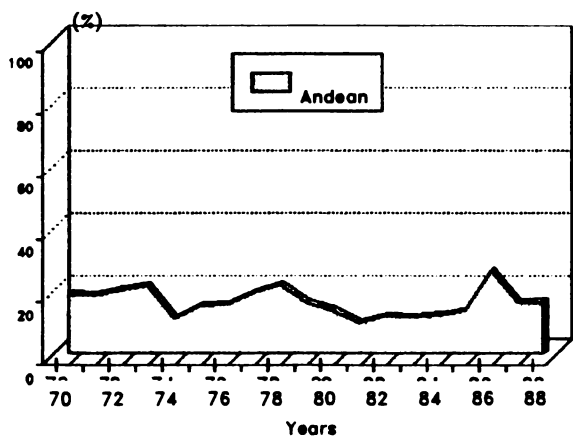
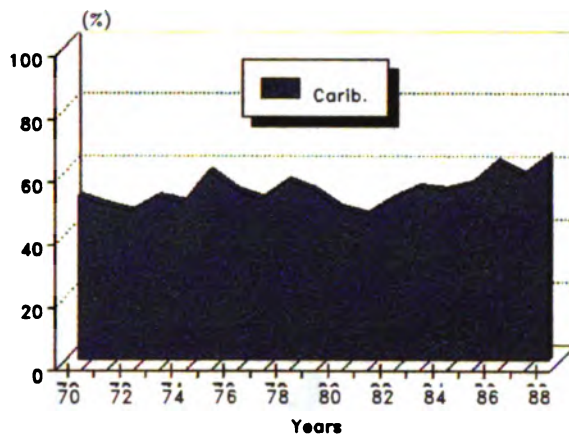
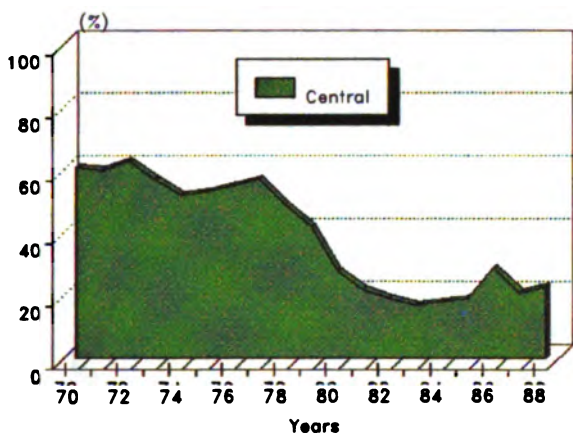
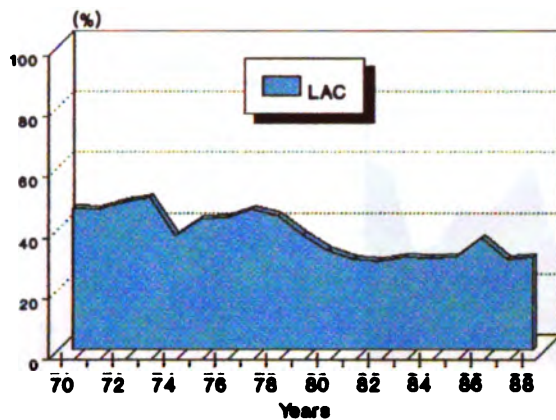

Figure 28
LAC: Value of Exports of Selected
Agricultural Products (1970–1989)

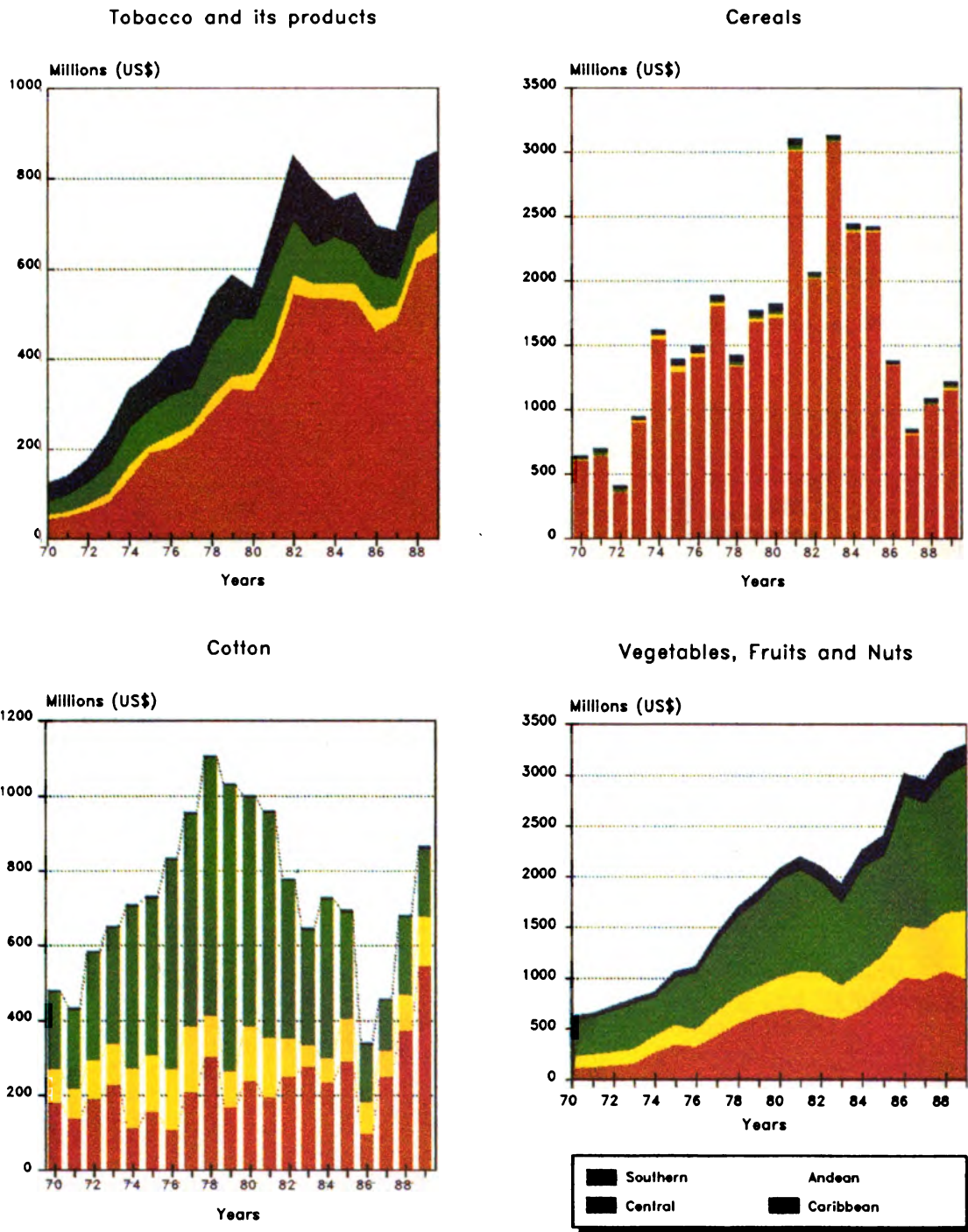

Figure 29

LAC: Value of Exports of Selected Agricultural Products (1970–1989)

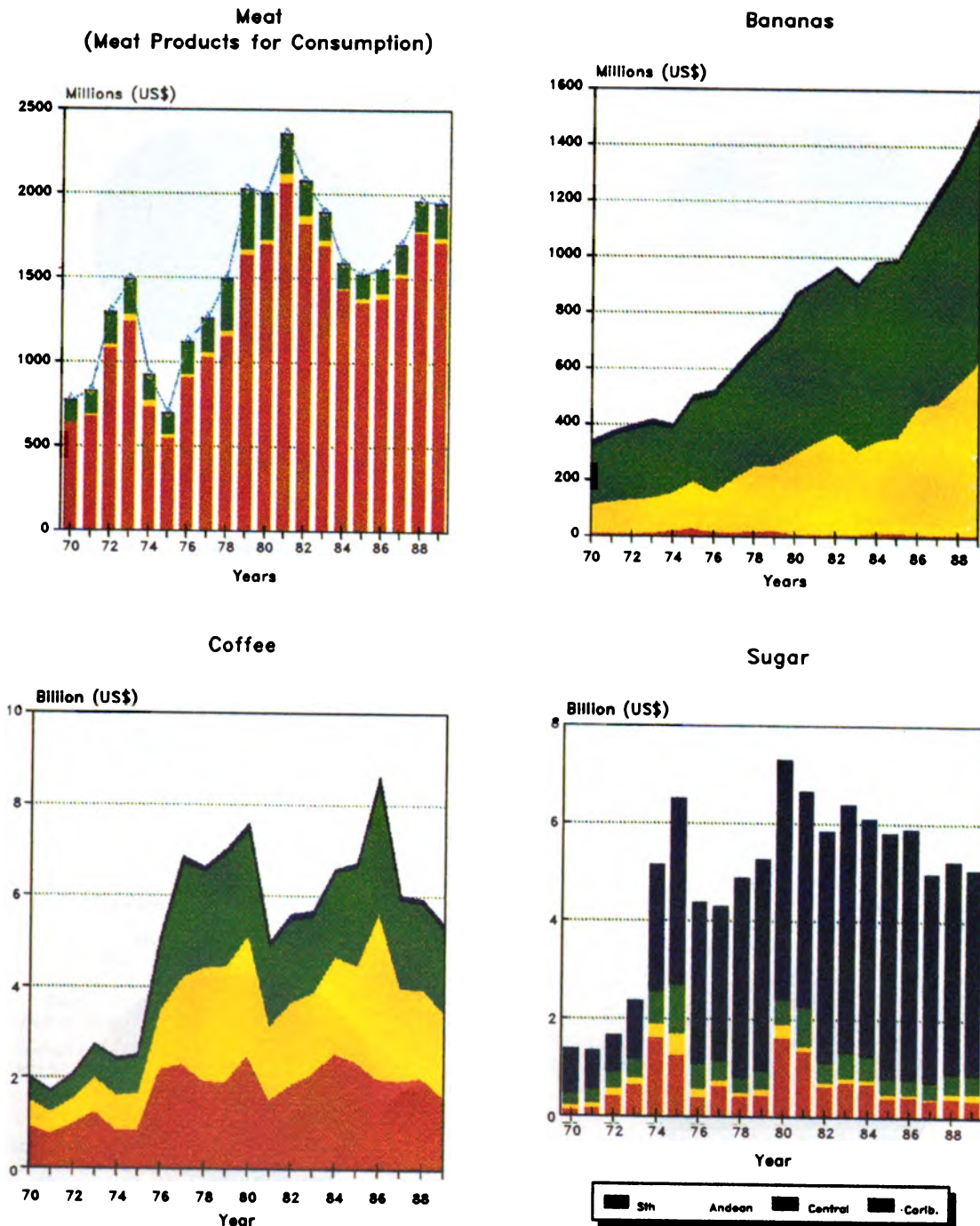
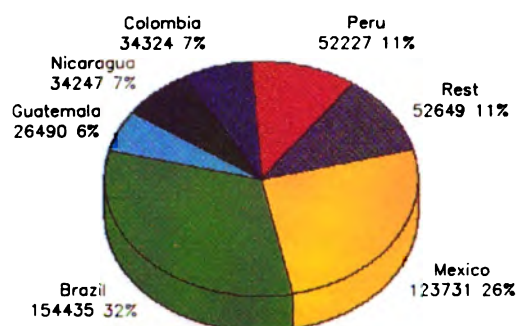

Figure 30

LAC: Countries Dominant in Exports of Cotton and Meat Products in 1970, 1980 and 1989
(Thousands of US dollars and percentage of total value)

Cotton (1970)



Meat Products (1970)

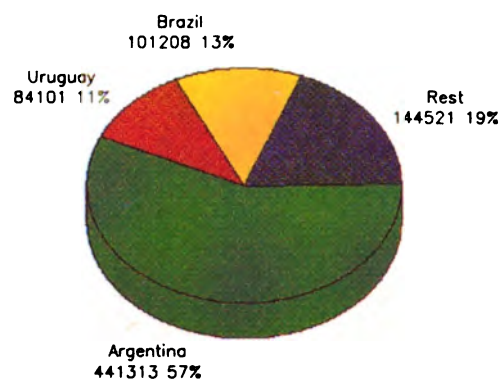

Cotton (1980)

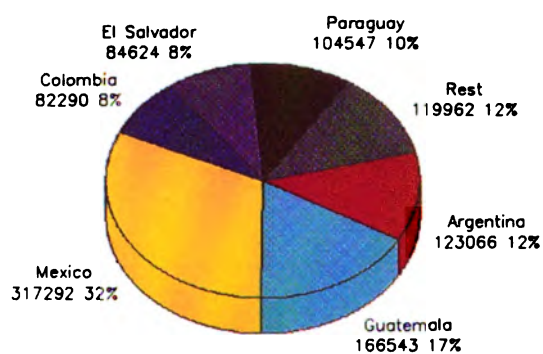

Meat Products (1980)

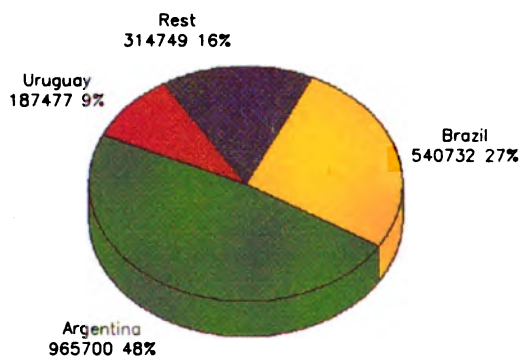

Cotton (1989)

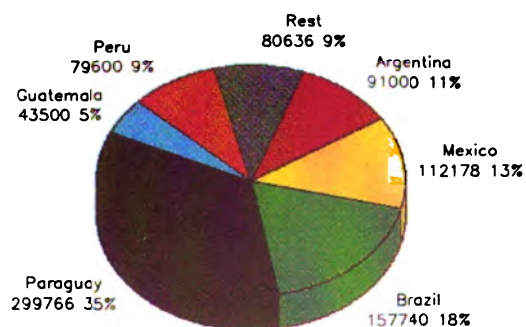

Meat Products (1989)

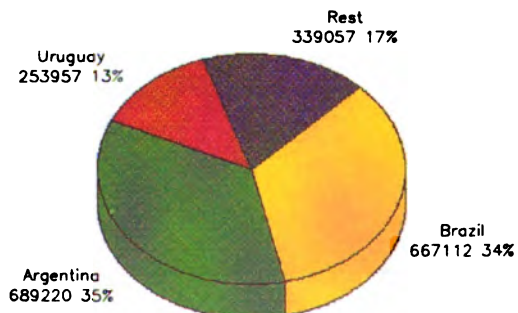
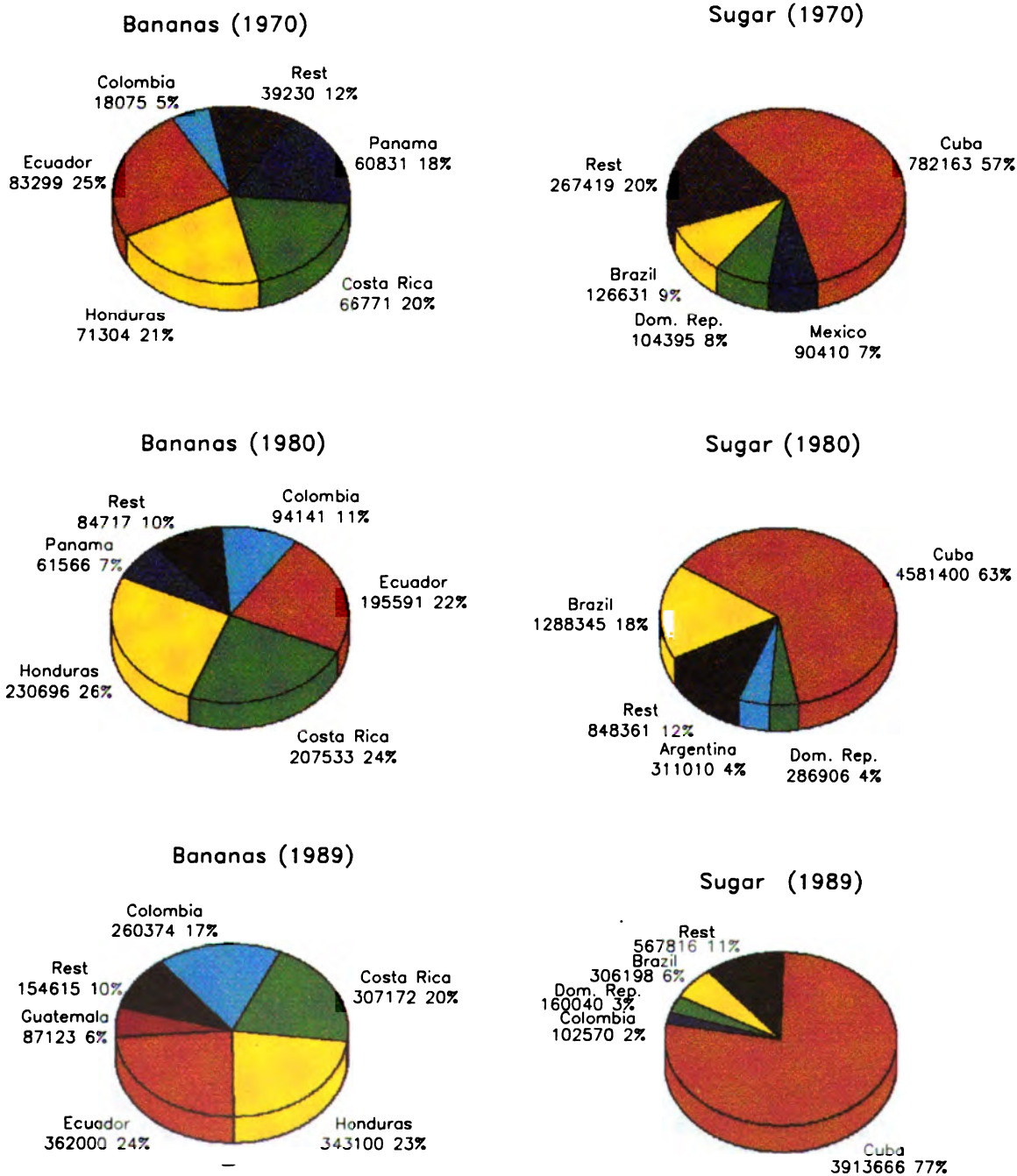

Figure 31

LAC: Countries Dominant in Exports of Bananas and Sugar in 1970, 1980 and 1989
(Thousands of US dollars and percentage of total value)



Meat. The high value of the meat exports of Argentina, Brazil and Uruguay place the Southern Area first in its share of LAC's total exports, with an average market share of 84 percent. Argentina is the country with the highest contribution to total exports (Figure 30).

Grains. Argentina and Uruguay account for more than 92 percent of overall grain exports. The former registers the highest contribution to the total export value (Figure 32).

Tobacco. Brazil and Cuba are the main exporters of tobacco and its by-products, with the peculiarity that, whereas the value of Brazil's exports increased from 27 percent in 1970 to 58 percent in 1989, Cuban tobacco exports remained stagnant (Figure 33). Another country that registered a significant relative share during the last two periods in question was Argentina, with a share that rose from 5 percent in 1980 to 7 percent in 1989.

Vegetables, fruits and nuts. Mexico, Chile, Argentina, Honduras, Costa Rica and Ecuador average 71 percent of total exports of vegetables, fruits and nuts. Chile, with a sustained increase in exports of these products, bettered its position from eighth to first place in its contribution to the total exported by LAC. In contrast, Argentine exports did not surpass the ceiling of US\$319 million reached in 1979. In 1970 and 1980, Mexico occupied first place, ceding its predominance to Chile in 1989 (Figure 33).

Exports by Groups of Countries

The grouping of trade figures makes it possible to offer an approximate idea of how exports from the countries of the Group of 3 (Colombia, Venezuela and Mexico) have developed in comparison with the rest of LAC; and those of the NAFTA nations (Canada, U.S. and Mexico) with respect to the rest of the Americas.

In contrasting the countries of NAFTA with the rest of the Americas, the figures for 1970, 1980 and 1989 were reviewed (Figures 34 to 37). The former group acquires relative importance in coffee, grain and meat exports.

In regard to the distribution of the figures for LAC into two blocs, made up of the Group of 3 and the rest of the region, also for 1970, 1980 and 1988 or 1989, Figures 34 to 37 show that the exports of the former account for an increasing share in coffee; and a relative importance in sugar and meat which decreases and subsequently increases.

Overall Exports by Area

Total exports from the bloc of selected countries are destined largely for the countries of LAC. During the 1968-1991 period, only 13 percent of total exports supplied the regional market. As to the proportion of exports destined to the region, the Andean Area registered the highest level, with 25 percent, and the Central Area the lowest, with around 10 percent (Figure 38).

Figure 32

LAC: Countries Dominant in Exports of Coffee and Cereals in 1970, 1980 and 1989
(Thousands of US dollars and percentage of total value)

Coffee (1970)

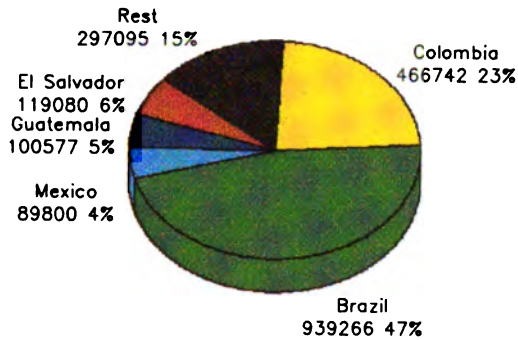

Cereals (1970)

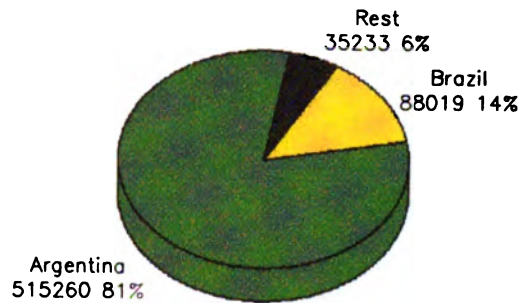

Coffee (1980)

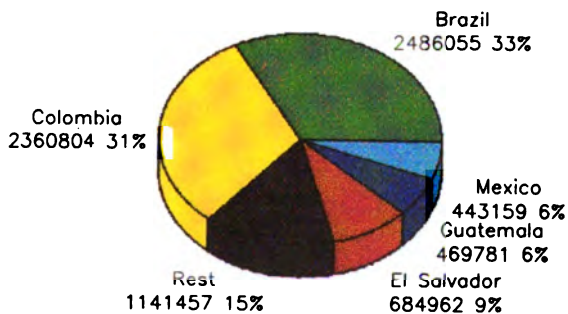

Cereals (1980)

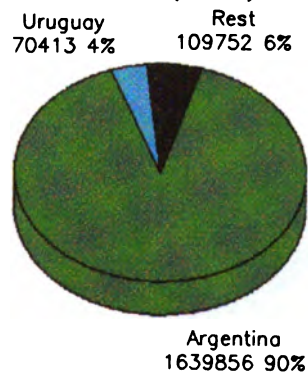

Coffee (1989)

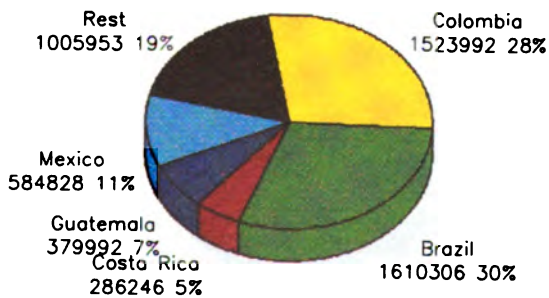

Cereals (1989)

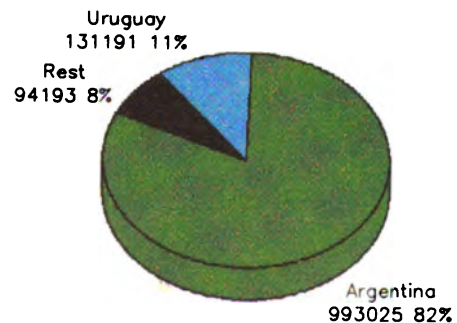
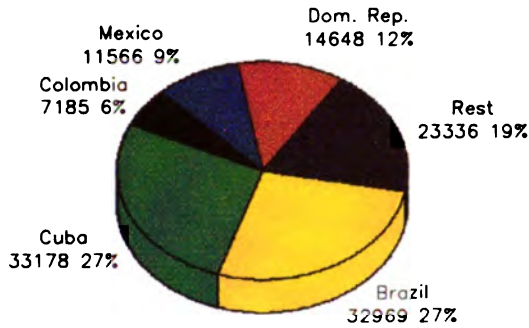

Figure 33

LAC: Countries Dominant in Exports of Tobacco and Vegetables, Fruits and Nuts in 1970, 1980 and 1989
(Thousands of US dollars and percentage of total value)

Tobacco and its Products (1970)



Vegetables, Fruits and Nuts (1970)

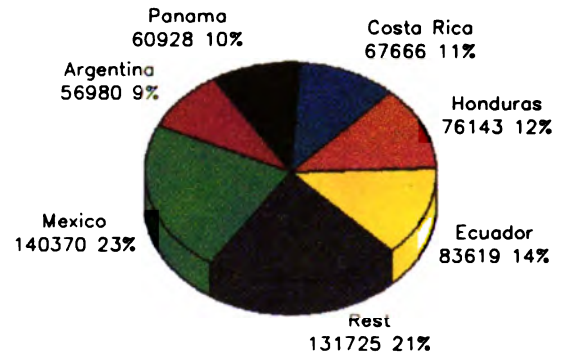

Tobacco and its Products (1980)

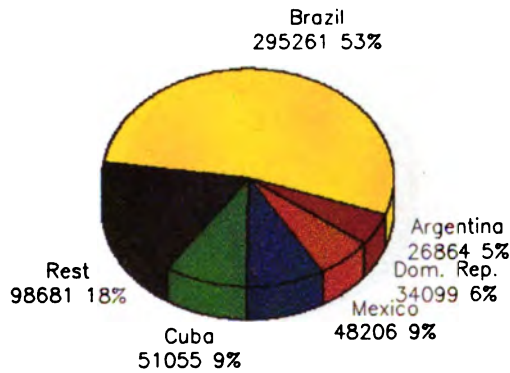

Vegetables, Fruits and Nuts (1980)

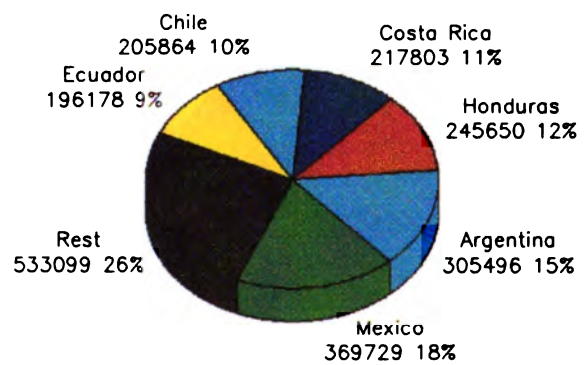

Tobacco and its Products (1989)

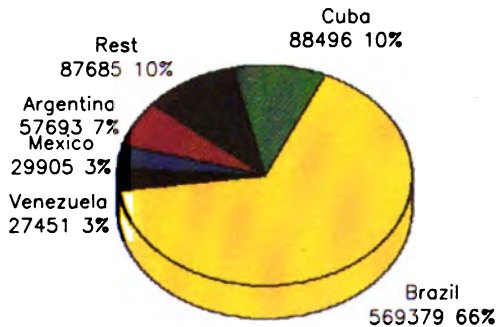

Vegetables, Fruits and Nuts (1989)

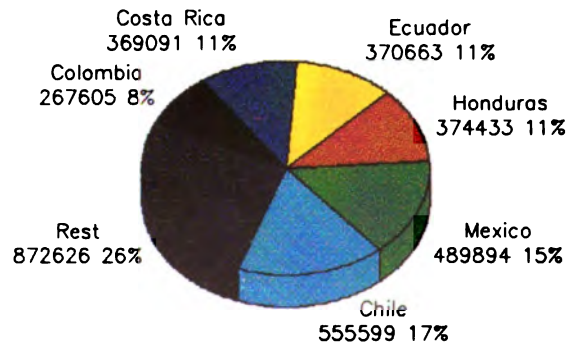
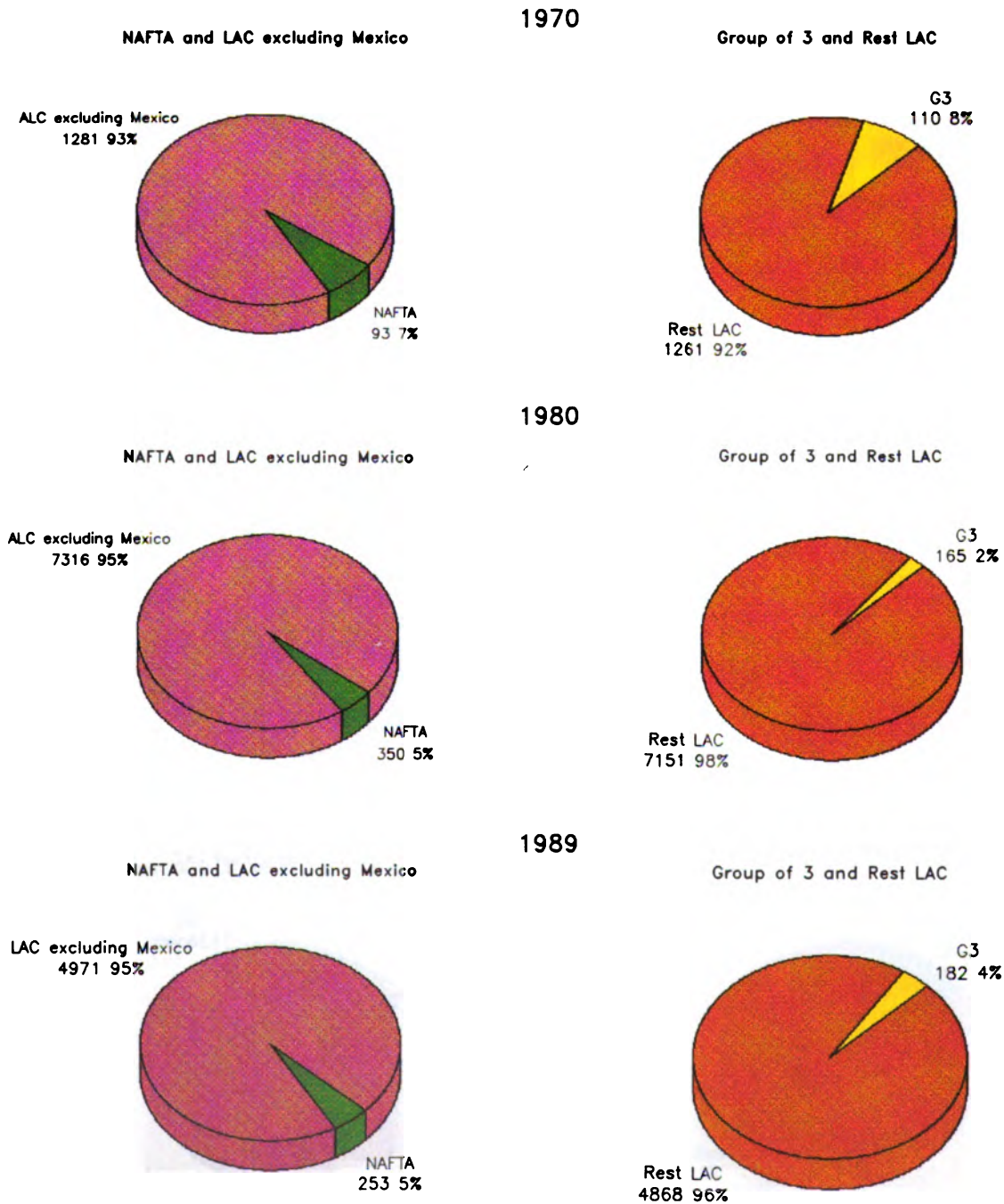

Figure 34

LAC, Group of 3, NAFTA: Exports of Sugar by Groups of Countries in 1970, 1980 and 1989
(Millions of US dollars and percentages)



NAFTA: Canada, United States of America and Mexico
Group of 3 (G3): Mexico, Colombia and Venezuela

Figure 35

LAC, Group of 3, NAFTA: Exports of Coffee by Groups of Countries in 1970, 1980 and 1989
(Millions of US dollars and percentages)

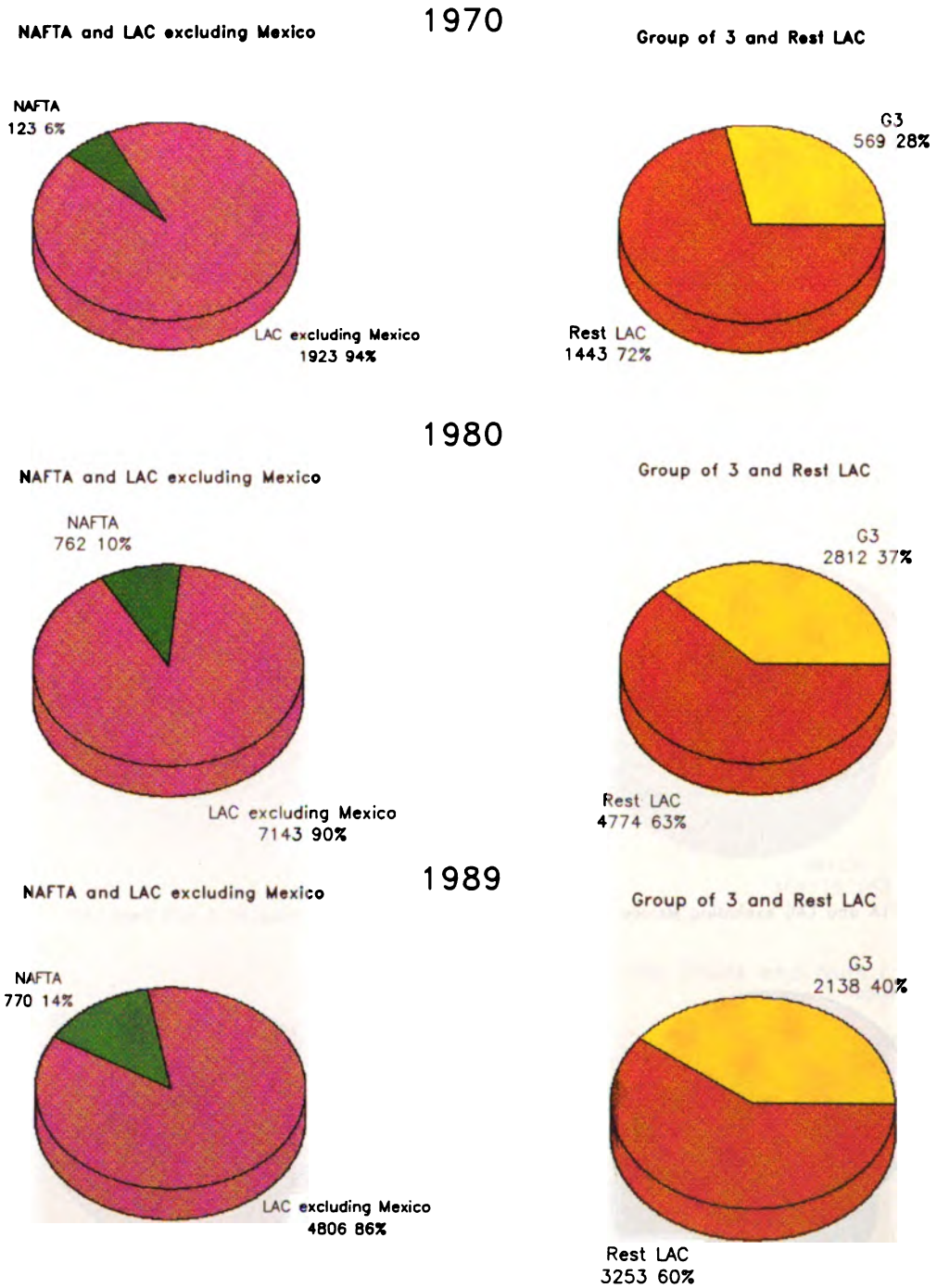

NAFTA: Canada, United States of America and Mexico
Group of 3 (G3): Mexico, Colombia and Venezuela

Figure 36

LAC, Group of 3, NAFTA: Exports of Cereals by Groups of Countries in 1970, 1980 and 1989
(Millions of US dollars and percentages)

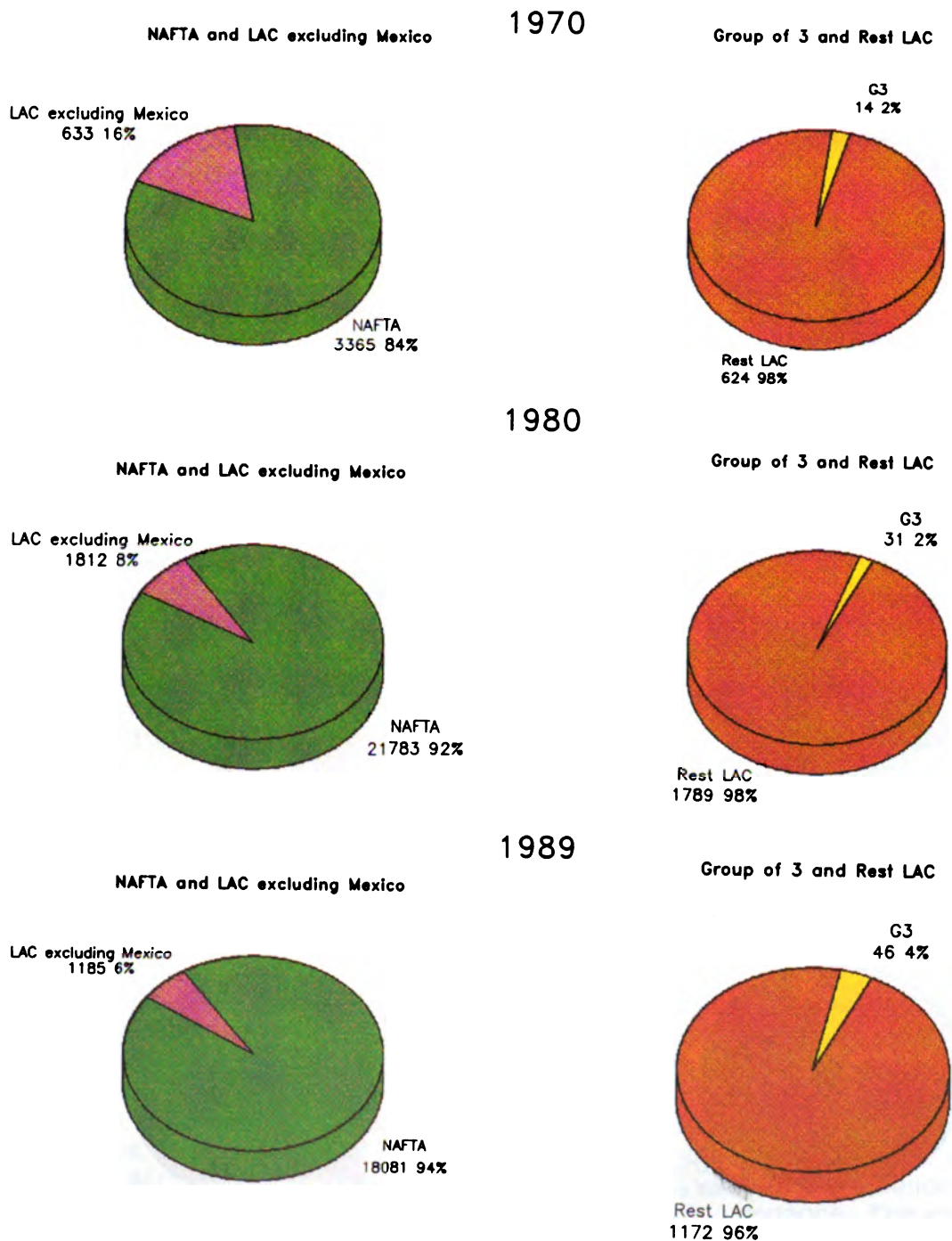

NAFTA: Canada, United States of America and Mexico
Group of 3 (G3): Mexico, Colombia and Venezuela

Figure 37

LAC, Group of 3, NAFTA: Exports of Meat Products
by Groups of Countries in 1970, 1980 and 1989
(Millions of US dollars and percentages)

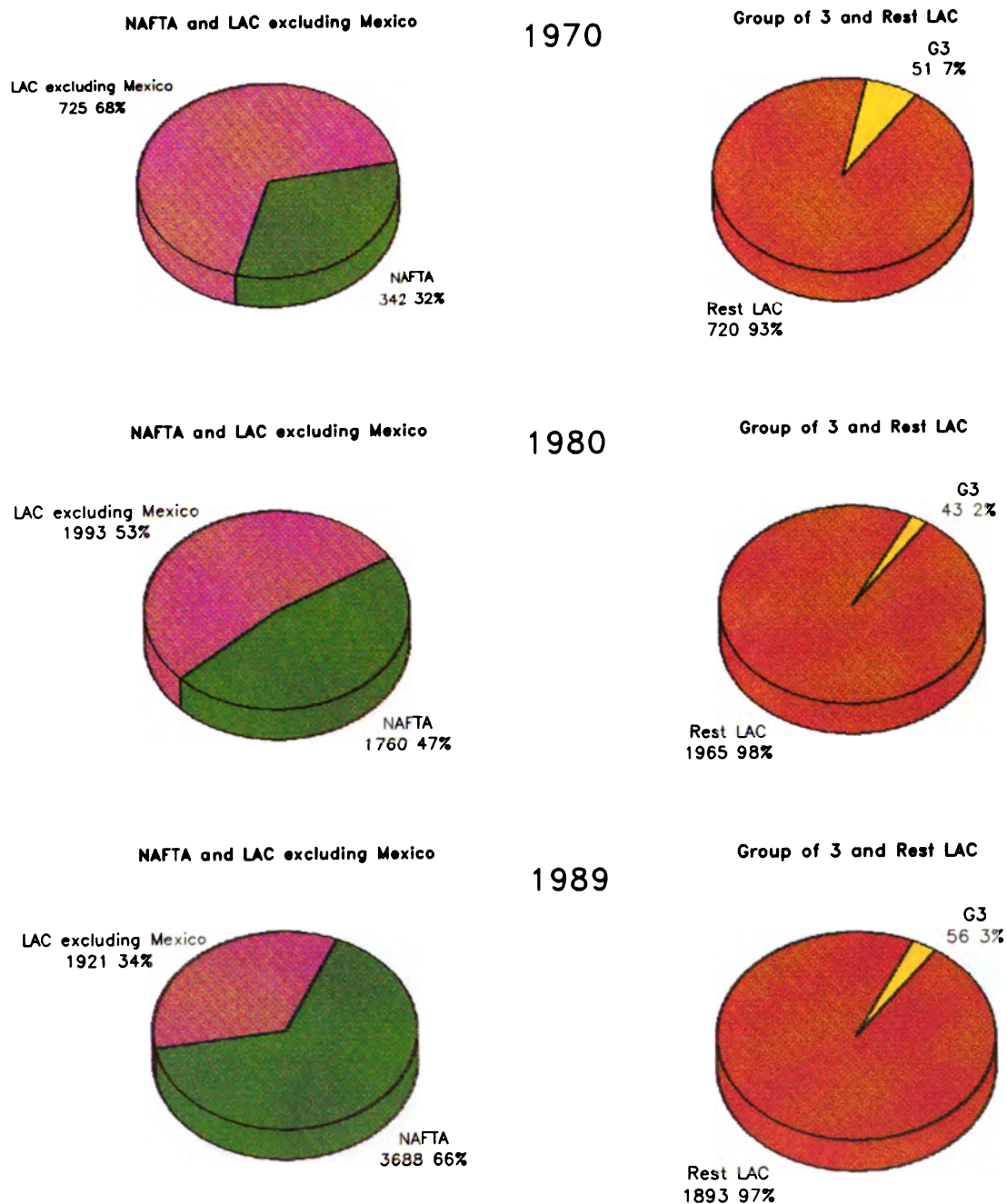

NAFTA: Canada, United States of America and Mexico
Group of 3 (G3): Mexico, Colombia and Venezuela

A high concentration of total exports in only a few countries may be observed, one of which accounts for more than the rest of the countries in each area. Brazil is the largest exporter in the Southern Area, with a contribution of more than 60 percent of the total. Venezuela accounts for 58 percent of Andean exports, while Mexico contributes 76 percent of the total exported by the Central Area.

As regards the relative weight of each area in the total exported, the Southern Area has a clear predominance, since it includes three of LAC's top five exporting countries (Brazil, Argentina and Chile); there is a balance between the relative shares of the Central and Andean areas, averaging 26 and 27 percent of the total for LAC, respectively, and a low share of 5 percent of the total for the Caribbean Area.

Agricultural Imports: Overall and by Groups of Commodities

Agricultural imports registered an upward trend during the 1970s, reaching a high point in 1981; thereafter, a downturn can be observed, with signs of change at the end of the decade (Figure 39). The upward trend of the 1970s is replicated —although to different degrees— in the imports of all four areas under consideration.

In the 1980s, however, no common pattern is revealed in the performance of imports among the different areas. Central Area imports suffered an initial downturn in 1982, made a partial recovery and once again experienced a reduction in the value imported, then made a recovery again at the end of the decade. In the Southern Area there was a drastic reduction in imports, reaching the lowest point in 1985, with a significant recovery the following year and a further downturn at the end of the decade. In the Andean Area, agricultural imports showed a prolonged downturn until 1988, when a recovery began. Caribbean agricultural imports showed a downward trend, with an upturn towards the end of the 1980s.

To provide greater detail on the evolution of imports, a group of products made up of the following subgroups was selected: grains; dairy products and eggs; meat products; vegetables, fruits and nuts; vegetable oils; sugar; fibers; and live animals. The combined value of imports of these products followed a pattern similar to that observed for total imports of agricultural products, which can be attributed to their significant relative share (chart at top of Figure 40).

The relative contribution of each subgroup in 1970, 1980 and 1989 can be established by means of a cross-section analysis (charts of relative structures, Figure 40). The share of grains is particularly significant, with values relative to the group total of 44 percent (1970), 53 percent (1980) and 38 percent (1989). Livestock products occupy an important position owing to their high share in the three years under study; at the end of the 1980s, the dairy products and eggs subgroup contributed 18 percent, while meat products accounted for 13 percent of the total import value of the products selected. Imports of vegetables, fruits and nuts declined in relative importance. The value of fiber imports experienced a fall-off and a recovery that, by the end of that decade, placed them at the same level as in 1970. The contribution of vegetable oils to total imports of the group of products under consideration fluctuated between 6 percent (1980) and 9 percent (1989).

Figure 38

LAC: Destination of Exports – Total Value in US dollars
(1970 – 1991)

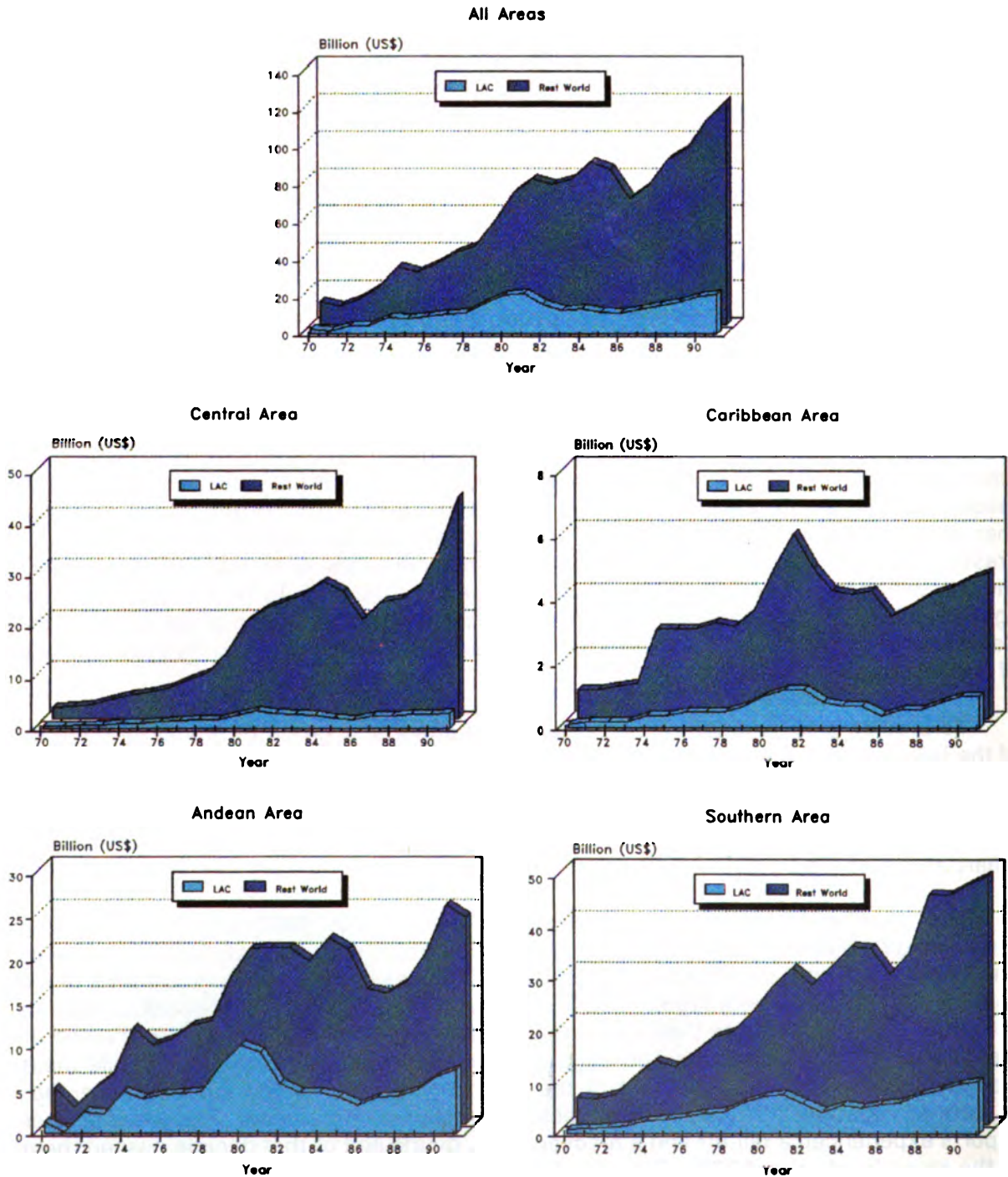
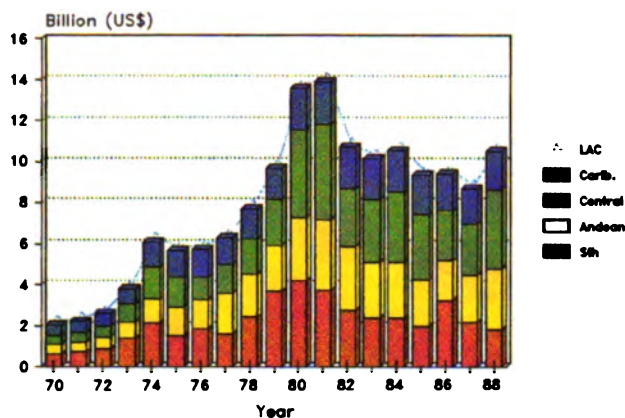
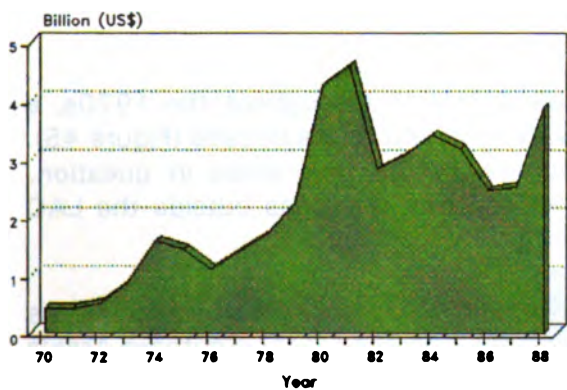

Figure 39
LAC: Agricultural Imports by Area
(1970 - 1988)

LAC



Central



Caribbean

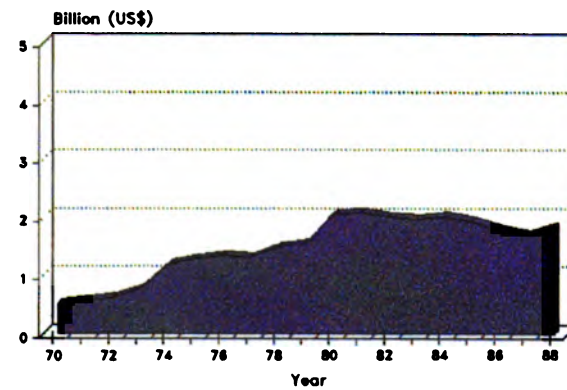

Andean

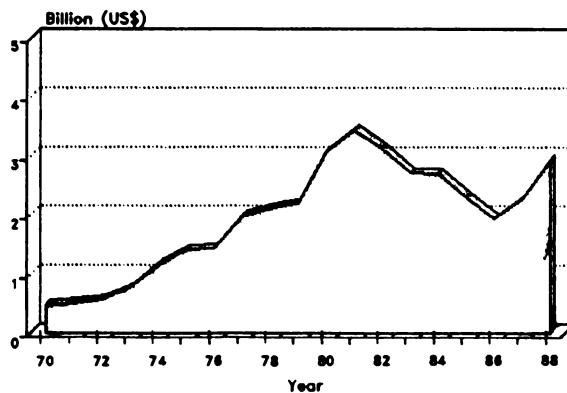

Southern

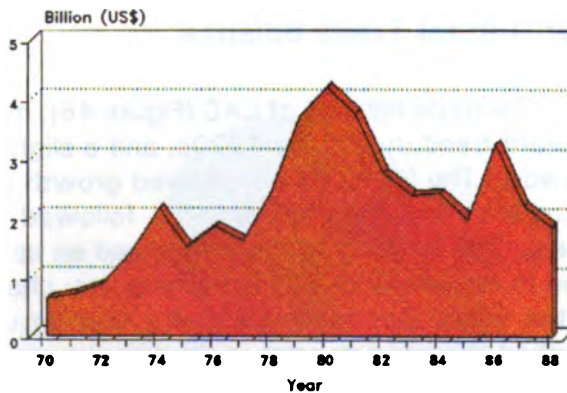

Imports by Groups of Countries

Data on imports makes it possible to observe the evolution of imports in the countries of the Group of 3 (Colombia, Venezuela and Mexico) with respect to the rest of LAC; and those of the NAFTA countries (Canada, the United States and Mexico) in comparison with the rest of the Americas.

With regard to the distribution of imports between the NAFTA countries and the rest of the Americas, the figures for 1970, 1980 and 1988 or 1989 were compared (Figures 41 to 44). The results show that the relative weight of the NAFTA countries in total grain imports increases; their relative share in meat products, vegetables, fruits and nuts, and vegetable oils decreases and then increases.

The breakdown of the figures for the Group of 3 and the rest of LAC (Figures 41 to 44) show a gain in the percentage share of the Group of 3 in the following commodities: meat products, grains and vegetable oils, and a relative share that increases and then diminishes in vegetables, fruits and nuts.

Overall imports

Total imports of commodities shows significant growth throughout the 1970s, a downturn in the early eighties and a recovery towards the end of the decade (Figure 45). This performance is replicated, to differing degrees, in the four areas in question. Increased growth is linked to increases in the imports from countries outside the LAC region.

One country contributes more to the value of imports than the rest of the countries put together in three of the areas. Brazil accounted for 62 percent of the Southern Area's total imports. Venezuela accounted for 51 percent of the Andean Area's imports, and Mexico's share of total Central Area imports was 68 percent.

Agricultural Trade Balance

The trade balance of LAC (Figure 46), measured in current U.S. dollars, shows a clear upward trend during the 1970s, and a slight rise, with fluctuations, during the following decade. The Central Area showed growth until 1979; in the following years, there was a sudden drop in its net exports, followed by a recovery and a fall-off in the final two years. The Andean Area experienced an upward trend during the 1970s, with a relative drop in exports with respect to imports, changing the trade balance for 1981 and 1982. In the years that followed, there was an upturn in the trade balance, which in 1986 reached the highest point in the twenty years under consideration, and was followed by a contraction. In the Southern and Caribbean areas, this variable showed a general upward trend over the last two decades.

Figure 40

LAC: Imports of Selected Products by Year
(1970 - 1989)

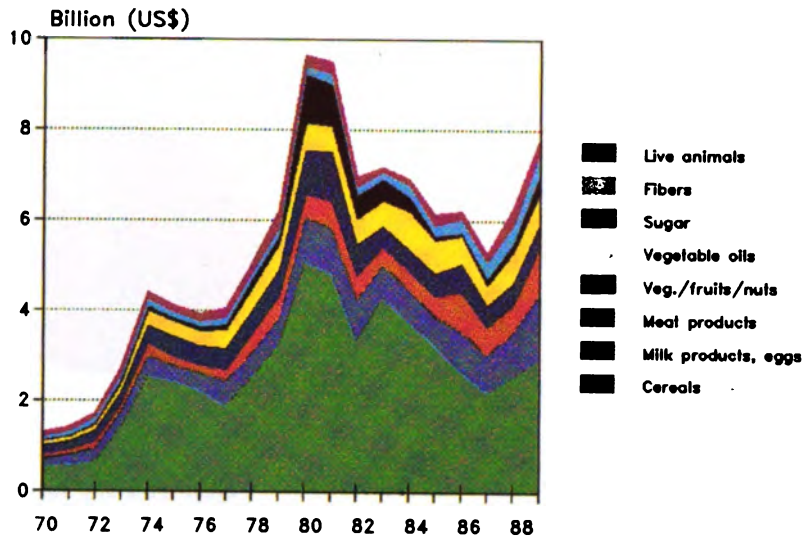

LAC: Imports of Selected Agricultural Products
(Relative structure)
1970

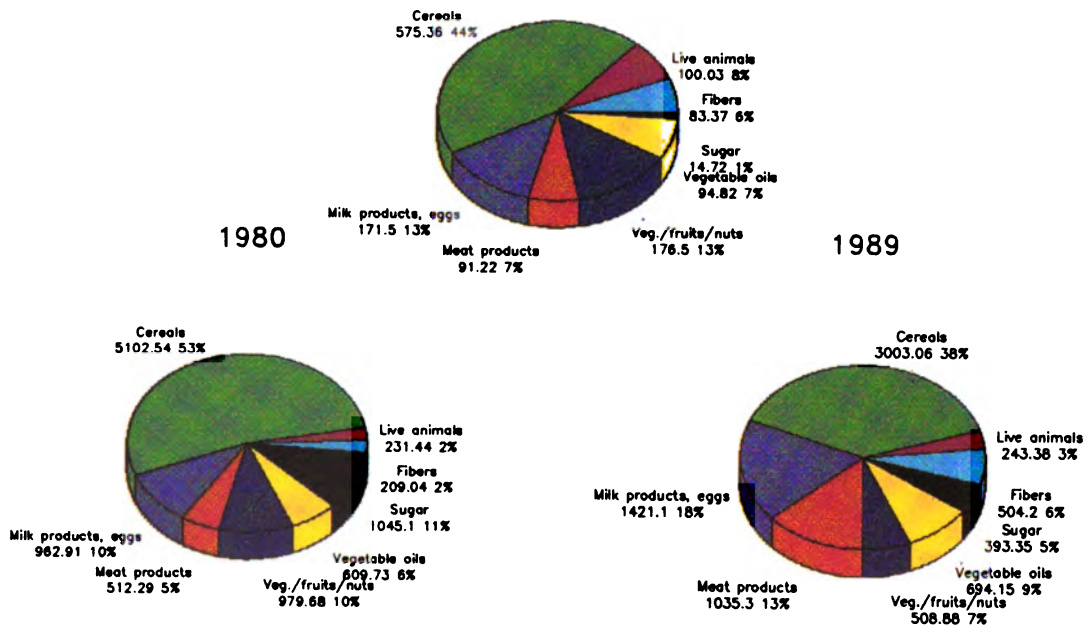
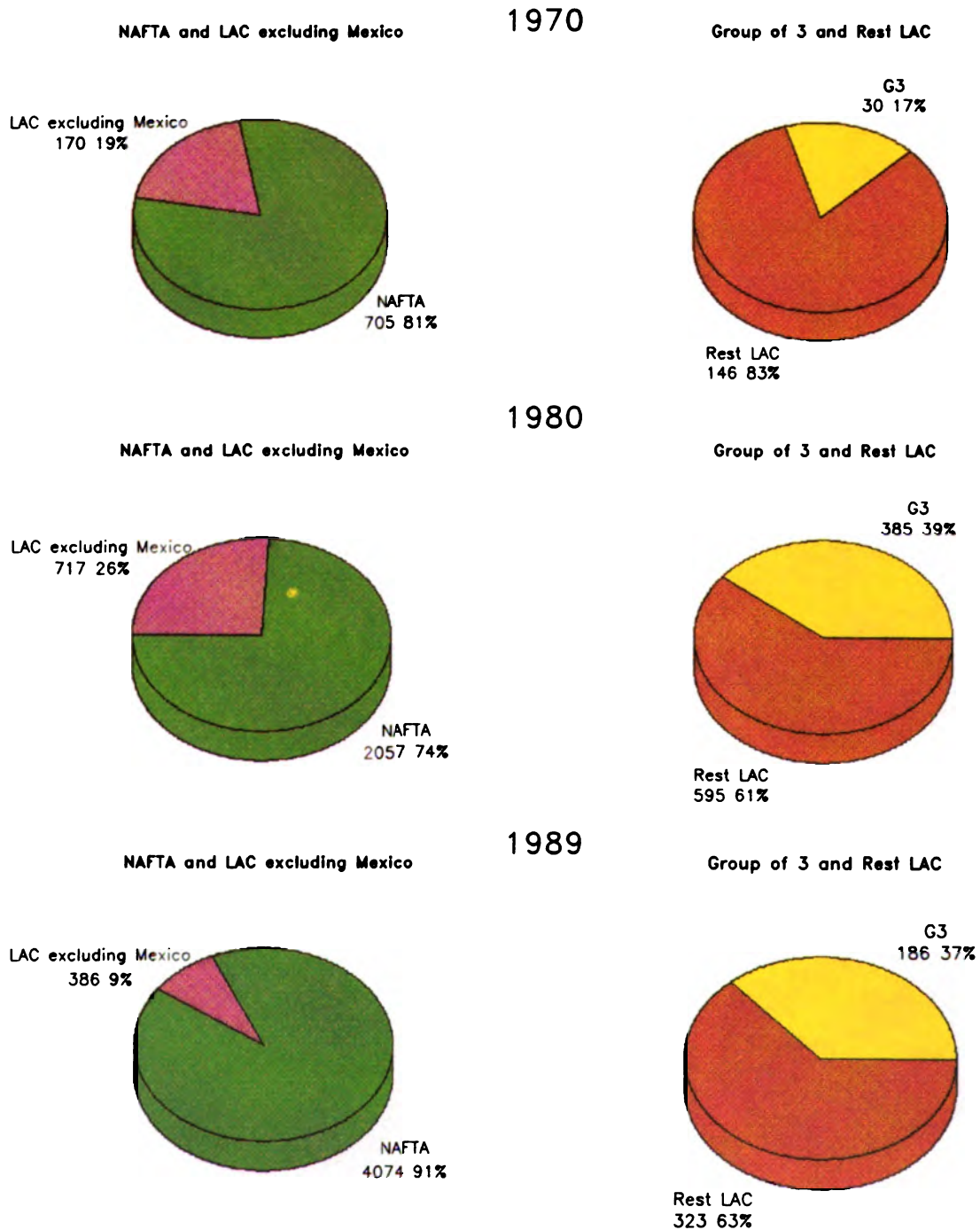

Figure 43

LAC, Group of 3, NAFTA: Imports of Vegetables, Fruits and Nuts by Group of Countries in 1970, 1980 and 1989 (Millions of US dollars and percentages)



NAFTA: Canada, United States of America and Mexico
 Group of 3 (G3): Mexico, Colombia and Venezuela

Figure 42
LAC, Group of 3, NAFTA: Imports of Cereals
by Group of Countries in 1970, 1980 and 1989
(Millions of US dollars and percentages)

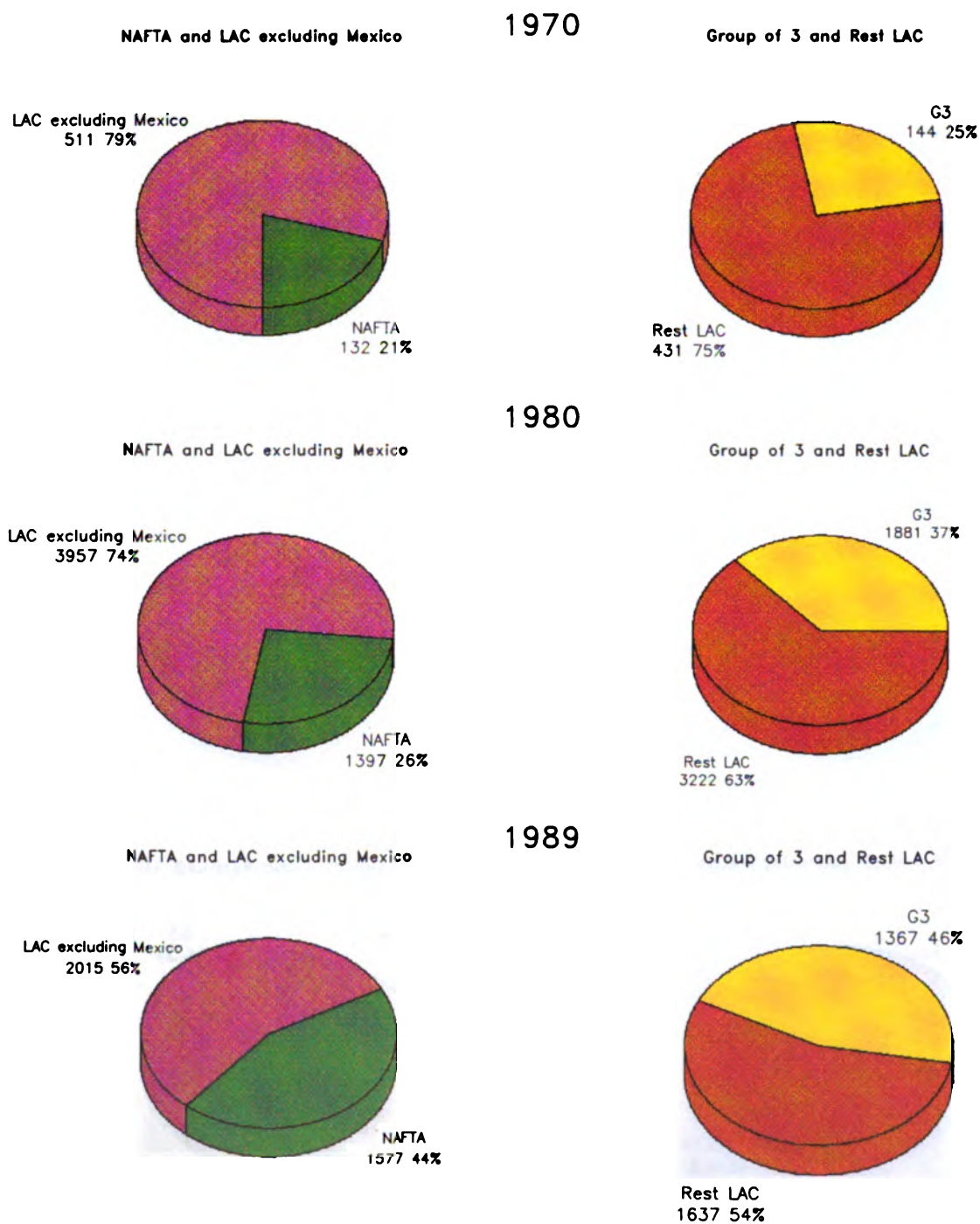

NAFTA: Canada, United States of America and Mexico
Group of 3 (G3): Mexico, Colombia and Venezuela

Figure 45
LAC: Value of Total Imports by
Origin and Area (1970 - 1991)

All Areas

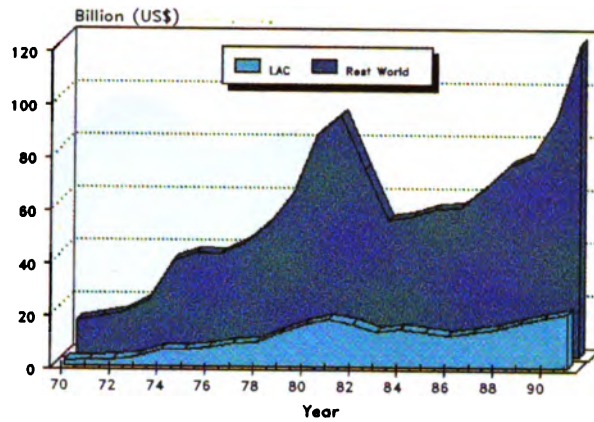

Central Area

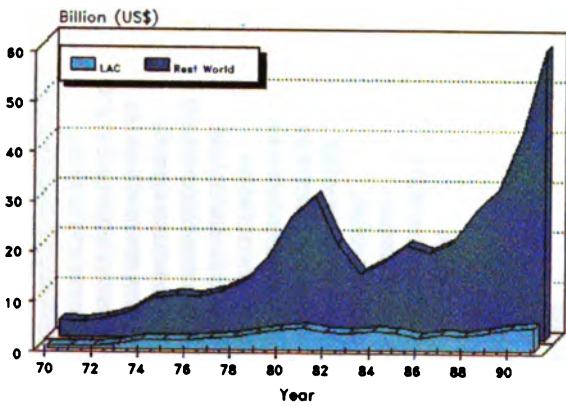

Caribbean Area

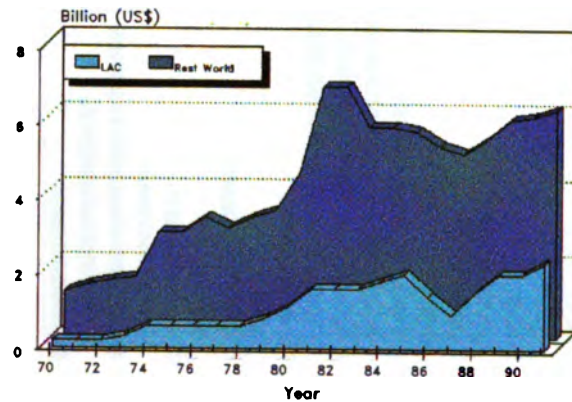

Andean Area

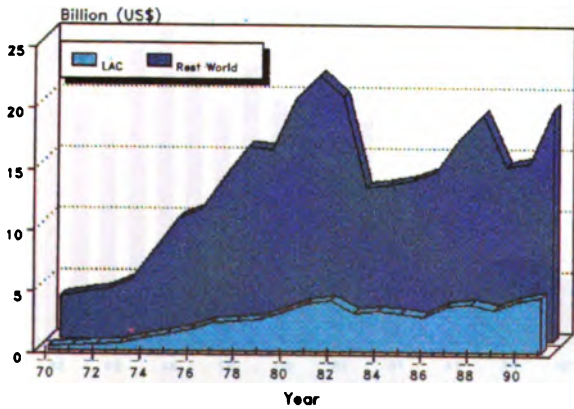

Southern Area

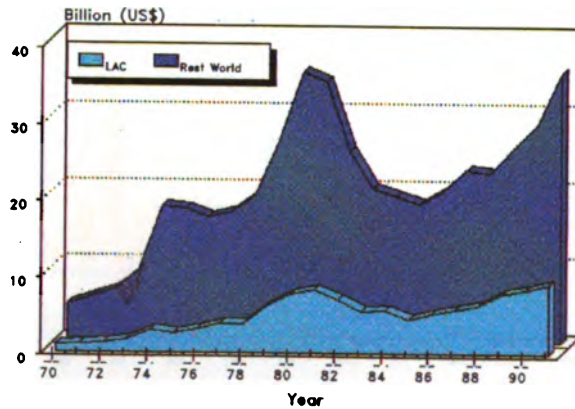
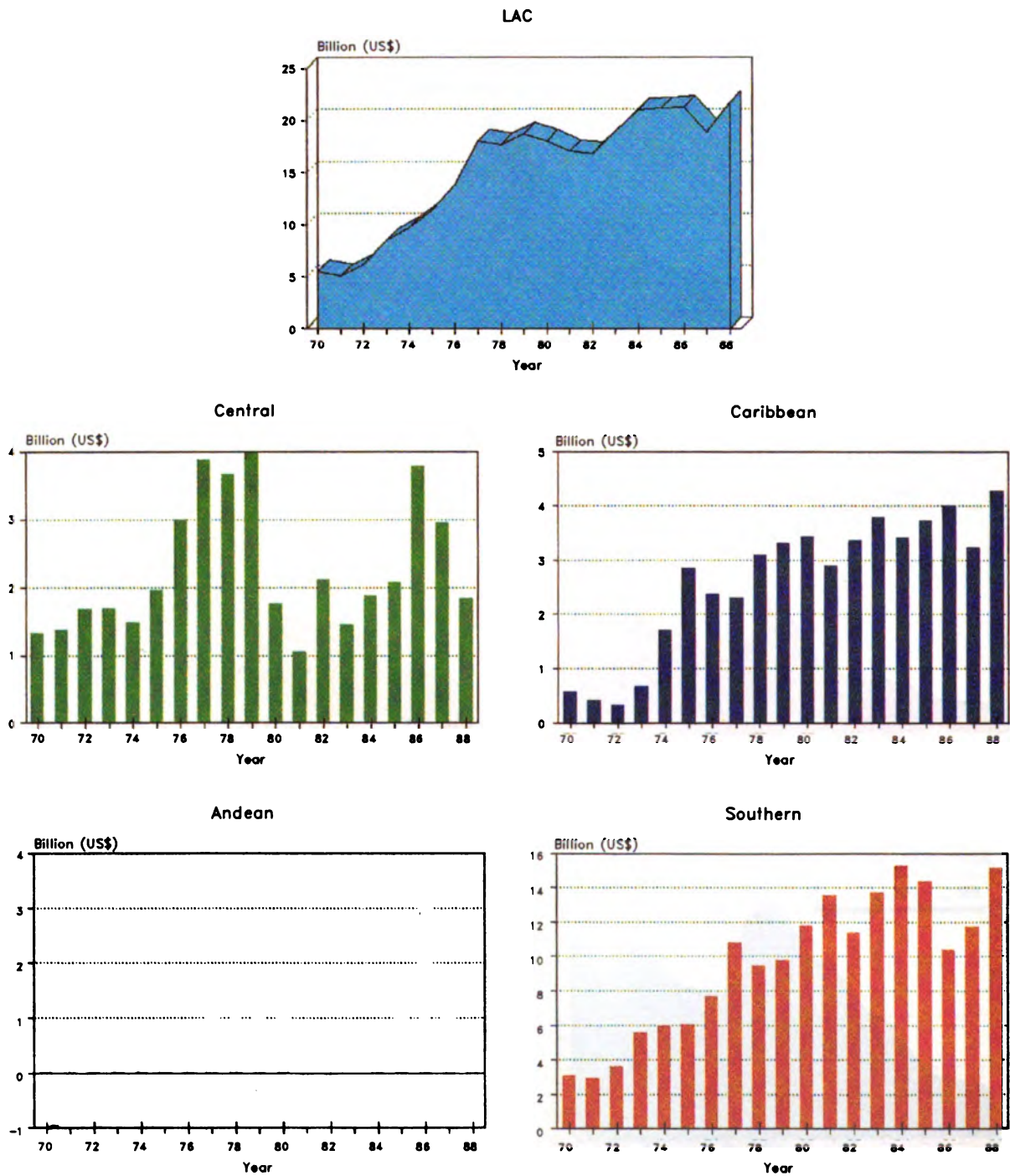

Figure 46
LAC: Agricultural Trade Balance by Area
(Exports minus Imports) (1970 - 1988)



BIBLIOGRAPHY

BOGANTES, R. 1990. Diccionario del Sistema de Información para el Análisis de Política Agraria en América Latina y el Caribe. IICA, San José, C.R. 150p.

CASAS, L. DE LAS; BOGANTES, R. 1992. Usando el SIAPA. IICA, Bogota, Col. 64p.

IICA (INTER-AMERICAN INSTITUTE FOR COOPERATION ON AGRICULTURE); FLACSO (LATIN AMERICAN SCHOOL OF SOCIAL SCIENCES). 1991. Centroamérica en Cifras. San Jose, C.R. 245p.

PISKULICH, R. 1991. Sistema de Información para el Análisis de Política Agraria: Versión especial para Centroamérica. IICA. San Jose, C.R. 54p.

USDA (UNITED STATES DEPARTMENT OF AGRICULTURE). World agriculture: Trends and indicators, 1961-89. Economic Research Service. Statistical Bulletin No. 815. 552p.

LIST OF FIGURES

Page

Figure 1	LAC: Harvested Area by Area in 1970, 1980 and 1989 (Millions of hectares)	13
Figure 2	LAC: Volume of Production of Commodities in 1970, 1980 and 1989 (Millions of metric tons)	14
Figure 3	LAC: Area of Arable Land and Permanent Crops, Permanent Pastures and Forest Lands (Thousands of hectares and percentages)	15
Figure 4	LAC, USA, Canada: Forested Area (Percentages and thousands of hectares)	16
Figure 5	LAC: Area Under Irrigation (1970-1987)	17
Figure 6	LAC: Comparison of Production of Cereals with Bananas and Vegetables (Thousands of metric tons and percentages)	20
Figure 7	LAC: Production of Bananas and Vegetables by Area in 1970, 1980 and 1989 (Percentages and thousands of metric tons)	21
Figure 8	LAC: Comparison of Production of Cereals with Fruits and Coffee (Thousands of metric tons and percentages)	22
Figure 9	LAC: Production of Fruits and Cereals by Area in 1970, 1980 and 1989 (Percentages and thousands of metric tons)	23
Figure 10	LAC: Comparison of Production of Cereals with Beef and Poultry Meat (Thousands of metric tons and percentages)	24
Figure 11	LAC: Volume of Production of Poultry Meat and Beef (Thousands of metric tons and percentages)	25
Figure 12	LAC: Production of Beef and Poultry Meat by Area in 1970, 1980 and 1989 (Thousands of metric tons and percentages)	26

Figure 13	LAC, USA, Canada: Volume of Production of Commodities in 1970, 1980 and 1989 (Millions of metric tons)	29
Figure 14	LAC, Group of 3, NAFTA: Volume of Production of Rice in 1970, 1980 and 1989 (Thousands of metric tons and percentages)	30
Figure 15	LAC, Group of 3, NAFTA: Volume of Production of Corn in 1970, 1980 and 1989 (Thousands of metric tons and percentages)	31
Figure 16	LAC, Group of 3, NAFTA: Volume of Production of Wheat in 1970, 1980 and 1989 (Thousands of metric tons and percentages)	32
Figure 17	LAC, Group of 3, NAFTA: Volume of Production of Soybeans in 1970, 1980 and 1989 (Thousands of metric tons and percentages)	33
Figure 18	LAC, Group of 3, NAFTA: Volume of Production of Coffee in 1970, 1980 and 1989 (Thousands of metric tons and percentages)	34
Figure 19	LAC, Group of 3, NAFTA: Volume of Production of Fruits in 1970, 1980 and 1989 (Thousands of metric tons and percentages)	35
Figure 20	LAC, Group of 3, NAFTA: Volume of Production of Vegetables in 1970, 1980 and 1989 (Thousands of metric tons and percentages)	36
Figure 21	LAC, Group of 3, NAFTA: Volume of Production of Poultry Meat in 1970, 1980 and 1989 (Thousands of metric tons and percentages)	37
Figure 22	LAC, Group of 3, NAFTA: Volume of Production of Beef in 1970, 1980 and 1989 (Thousands of metric tons and percentages)	38
Figure 23	LAC: Ranges of Productivity of Cereals and Soybeans in 1970, 1980 and 1989 (Minimum, median and maximum values)	41
Figure 24	LAC: Ranges of Productivity of Coffee, Milk, Bananas and Eggs in 1970 and 1989 (Minimum, median and maximum values)	42

Figure 25	LAC: Ranges of Utilization of Inputs in 1970 and 1987 (Minimum, median and maximum values)	43
Figure 26	LAC: Agricultural Exports - Total and for Selected Products in 1970-1988	48
Figure 27	LAC: Agricultural Exports as a Proportion of Total Exports (1970-1988)	49
Figure 28	LAC: Value of Exports of Selected Agricultural Products (1970-1989)	50
Figure 29	LAC: Value of Exports of Selected Agricultural Products (1970-1989)	51
Figure 30	LAC: Countries Dominant in Exports of Cotton and Meat Products in 1970, 1980 and 1989 (Thousands of US dollars and percentage of total value)	52
Figure 31	LAC: Countries Dominant in Exports of Bananas and Sugar in 1970, 1980 and 1989 (Thousands of US dollars and percentage of total value)	53
Figure 32	LAC: Countries Dominant in Exports of Coffee and Cereals in 1970, 1980 and 1989 (Thousands of US dollars and percentage of total value)	55
Figure 33	LAC: Countries Dominant in Exports of Tobacco and Vegetables, Fruits and Nuts in 1970, 1980 and 1989 (Thousands of US dollars and percentage of total value)	56
Figure 34	LAC, Group of 3, NAFTA: Exports of Sugar by Groups of Countries in 1970, 1980 and 1989 (Millions of US dollars and percentages)	57
Figure 35	LAC, Group of 3, NAFTA: Exports of Coffee by Groups of Countries in 1970, 1980 and 1989 (Millions of US dollars and percentages)	58
Figure 36	LAC, Group of 3, NAFTA: Exports of Cereals by Groups of Countries in 1970, 1980 and 1989 (Millions of US dollars and percentages)	59
Figure 37	LAC, Group of 3, NAFTA: Exports of Meat Products by Groups of Countries in 1970, 1980 and 1989 (Millions of US dollars and percentages)	60

Figure 38	LAC: Destination of Exports: Total Value in US dollars (1970-1991)	61
Figure 39	LAC: Agricultural Imports by Area (1970-1988)	63
Figure 40	LAC: Imports of Selected Products by Year (1970-1989)	65
Figure 41	LAC, Group of 3, NAFTA: Imports of Meat Products by Group of Countries in 1970, 1980 and 1989 (Millions of US dollars and percentages)	66
Figure 42	LAC, Group of 3, NAFTA: Imports of Cereals by Group of Countries in 1970, 1980 and 1989 (Millions of US dollars and percentages)	67
Figure 43	LAC, Group of 3, NAFTA: Exports of Vegetables, Fruits and Nuts by Group of Countries in 1970, 1980 and 1989 (Millions of US dollars and percentages)	68
Figure 44	LAC, Group of 3, NAFTA: Exports of Vegetable Oils by Group of Countries in 1970, 1980 and 1989 (Millions of US dollars and percentages)	69
Figure 45	LAC: Value of Total Imports by Origin and Area (1970-1991)	71
Figure 46	LAC: Agricultural Trade Balance by Area (Exports minus Imports) (1970-1988)	72

**This book was printed at
IICA Headquarters
in Coronado, Costa Rica
in September, 1993,
with a press run of 750 copies.**



In this document, IICA is pleased to offer an overview of the scale of agricultural production and an appraisal of the major changes that have taken place in agriculture in the Americas in recent years. The principal changes that have been observed in production and trade in the Americas during the last two decades are examined through statistical data, indicators and charts. In geographical terms, the results are presented by country, area or subregion, and are consolidated at the regional level.

The first section presents information on changes in the production structure, with emphasis on changing patterns in the areas harvested, production and land use. The second deals with the development of productivity. The third section provides an analysis of foreign trade, including overall imports and exports of agricultural products as a whole and separately. These three sections are illustrated with charts.

The information is set out by blocs. The first, consisting of Latin America and the Caribbean (LAC), is subdivided into four areas: Central, Caribbean, Andean and Southern. The second includes the countries of the North American Free Trade Agreement (NAFTA): Canada, the United States of America and Mexico, which is compared with the rest of the Americas. The other bloc of countries is known as the Group of 3: Colombia, Mexico and Venezuela, which is contrasted to the rest of LAC.

Interpreting the data is left to the readers' discretion, so that they may draw their own conclusions. An explanatory description is provided of the direction and magnitude of only the most significant changes.