

PROJECT:



Operational Management and Geodecisional Prototype
to Track and Trace **AG**ricultural Production

New tools for precision livestock management





**Operational Management and Geodecisional Prototype
to Track and Trace **AG**ricultural Production**

New tools for precision livestock management



With the support of:



© Inter-American Institute for Cooperation on
Agriculture (IICA). 2009

IICA encourages the fair use of this document.
Proper citation is requested.

This publication is also available in electronic (PDF)
format in IICA's and PROCISUR's Web sites at
<http://www.procisur.org.uy> , <http://www.iica.int>

Editorial coordination: IICA, PROCISUR

Mechanical editing: IICA, PROCISUR

Layout: Esteban Grille

Cover: Esteban Grille

Printed: Boscana

New tools for precision livestock management / IICA,
PROCISUR – Montevideo.: IICA, 2009

60 p.; 18.7x26.5 cm.

ISBN 13: 978-92-9248-148-3

1. Livestock 2. Meat production 3. Productivity 4.
Economic competition I. IICA II. Título

AGRIS

DEWEY

E20

338.176213

Montevideo, Uruguay - 2009

Table of contents

Presentation	5
---------------------------	----------

Part 1

Reminder of objectives and actors.....	8
General objectives	8
Partners and Actors	10

Part 2: State of the art: Traceability in Europe, Quebec and Southern Cone countries

Laws, rules and regulations on traceability.....	16
A. Animal welfare	16
B. Animal identification	17
C. Food production and traceability	18
OTAG Quebec Research Contribution	20
ATQ research and assessment projects associated to OTAG (2005-2009)	20
Brazilian Traceability System (SISBOV).....	23
The Argentinean Traceability System.....	26

Part 3: Data and tool requirements

OTAG information system.....	28
Actors.....	28
Technological platform.....	30
UML Model	30
Development of electronic collars to track and trace cattle.....	32
Electronic collars	33
Power supply management.....	35
Base station.....	36
Base station software development	37
Towards a Spatial Decision Support System for Animal Traceability.....	38

Part 4

The OTAG Operational Prototype and its Web Management Interface	44
The OTAG Operational Prototype: Lessons from Experiments in France and Brazil	44
The Web Management Interface	45
User interface	47

Conclusion	50
References	50

Part 5

Dissemination and improvement.....	52
Direct and indirect impacts of OTAG.....	52
Dissemination of Results.....	53
Added value at European and International level.....	54
Interaction with other relevant research activities.....	54
ANNEX: Scientific references	57
Articles	57
Book chapters	57
Conferences	57

Presentation

The OTAG Project has been the first initiative where PROCISUR has been involved bringing precision tools applied to livestock management.

The possibility of integrating PROCISUR into this research consortium with European Union Organizations brought an additional value to the existing research capability of our Partners; in particular, to achieve a better understanding of risk management issues in extensive livestock production.

For Southern Cone countries with a large stock of grazing animals, the fact of improving livestock production track and trace, opens great opportunities, not only for studying animal behavior in grazing management experiments, but also for monitoring animal movement in production herd with different purposes, such as setting boundaries among countries for sanitary control.

It is of interest for PROCISUR to contribute with the publication and diffusion of the results of projects like this one, in order to consolidate a new international network using this advanced technologies, and to make a new contribution to the modernization and improvement of the efficiency of Agriculture.

Emilio Ruz
Executive Secretary
PROCISUR

Part 1



Reminder of objectives and actors

Dr. Dominique Didelot, Cemagref

General objectives

OTAG is a Specific Support Action implemented within the 6th Framework Programme of the EU commission. It may be used to help in preparations for future Community research and technological development policy activities including monitoring and assessment activities related to food safety and security.

The main objective of **OTAG** was to improve an Operational Agricultural Production Management and Geodecisional Prototype Platform to address the global challenges of track and trace emerging risks in beef production within the context of Southern Cone Countries, in particular Brazil and Argentina, and EU policies. The prototype was intended to be implemented and tested under control conditions in Campo Grande EMBRAPA Research Station in Brazil. To achieve this objective the following issues have been addressed:

- a. Animal mobility, land use and pasture management;
- b. Scale issues in the emerging risk management and disease control;
- c. Promotion of operational precision geomatics tools and methods based on emerging technology such as RFID, High resolution remote sensing, LBS, GIS, and DSS to favour sustainable beef production practices and sustainable landscape structure and function;
- d. Use of state of the art technologies for beef production, risk management and decision making (innovative contribution of Agri-traçabilité Québec <http://www.agri-tracabilite.qc.ca>);
- e. Promotion of new technological and operational platform for agricultural risk management (crisis situation, food safety and regulation, market changes, trade issues)

OTAG has integrated current knowledge and expertise from the Consortium Members as well as existing and emerging technologies into a geodecisional prototype system. **OTAG** has commenced an in-depth analysis of current practices throughout the beef production chain. Good expertise on user's and decision maker's expectations regarding the type of confidence they would like to see regarding food safety and quality regulations has been useful for orientating works. Results from previous industrial/socio-economic research have been taken into account with recommendations on beef production best practices, and a crisis and risk expectations analysis.

OTAG also intends to expand this work in order to cover the four geographic dimensions of longitude, latitude, altitude and time attached to a decisional polygon. Various techniques are currently employed to acquire and manage information related to beef production. Irrespective of how this data is recorded today, a standard recording ontology had to be devised and incorporated into the **OTAG** scheme.

Using product information as input, as well as its geographic origin, production methods and certification, movement over space and time, OTAG needed to take in account that in Brazil we do not have a cadastral system. With the absence of a cadastral system OTAG has thought about the way in which to innovate by proposing a new spatial and land management scheme of reference (see current thesis, described hereafter).

Although designing a prototype was the main objective, OTAG has also thought about the following steps, especially how to ensure that a practical, cost-effective, reliable and accurate risk management system scheme can be effectively put in place throughout a beef production chain, but can provide the means to create the necessary critical mass to ensure broad take up of the project's results.

Specific intended objectives	Measurable forecasted indicators
1. State of the art and emerging technology for Southern Cone Countries and issues of EU regulations	Online reports and technical notes
2. Put in place a practicable risk management system.	Peer review
3. Put in place a practicable risk management open source geodecisional system for extensive bovine production.	Internet accessibility
4. Implement a demonstrator in Brazil	Test results
5. Establish a set of workable and acceptable best practice recommendations for Southern Cone Countries for the Beef sector. Develop a better understanding of risk management issues in extensive bovine production.	Technical note Scientific reports
6. Consolidate the existing cooperation and create a new international network of partnerships within Southern Cone Countries, EU, mainly via Alcuefood ¹ , PETER ² projects and with Canada. Networking of national research activities.	Number of: - scientific missions - exchange of staff members - student exchanges
7. Knowledge transfer between partners facilitated by the Internet (efficient Website), workshops and meeting exchanges between the partners.	- 4 workshops - 2 peer review meeting - PhD and Master students - OTAG Website

1- ALCUEFOOD -“From European fork to Latin American farm”: an innovative networking platform for EU–LAC partnerships in food quality and safety R&D. www.alcuefood.org

2- PETER -Promoting European Traceability Excellence & Research- www.eu-peter.org

Other contributions of the OTAG project, such as “specific support action”, have been achieved or are still expected:

- to promote and sustain a “tripartite” R&D approach between Europe, Southern Cone Countries and Canada,
- to encourage participation of SMEs,
- to support policies and prepare future community RTD activities.

Human resources have been mobilized through the relevant permanent staff of each institution. Opportunities for complementary national funding have been sought through national R&D agencies and the private sector, with a view to improve and promulgate the prototype at the end of the project.

Partners and Actors

Partner 1: Cemagref (www.cemagref.fr) - Institut de recherche pour l'Ingénierie de l'Agriculture et de l'Environnement

Cemagref is a public agricultural and environmental research institute whose work focuses on sustainable development in non-urban areas. It contributes to the conservation and acceptable management of land and water systems, the growth of economic activity on a sustainable basis, and the prevention of associated risks. Besides advancing fundamental knowledge, Cemagref makes available its diagnostics and control methods, designs negotiation and management tools, develops innovative technologies and supports public and private enterprise with its skills and experience.

Cemagref develops specific scientific expertise, useful in this project, in the domains of:

- Information and communication technologies (ICT), focused on (i) the interoperability of the heterogeneous information systems used by farmers and their institutional and economical partners, (ii) data exchange and communication between environmental information systems and the associated conceptual design methodologies.
- Field monitoring using “ground-based systems”, by “ad hoc” autonomous measurement systems (soil, landscape, water, ...) and developing corresponding electronic devices.

Some of the main Cemagref contributors have been:



Gérard
Chuzel

Dominique
Didelot

Patrice
Faure

Philippe
Rameau

Marie Odile
Monod

J. Pierre
Chanet

Stephan
Bernard

François
Pinet

Partner 2 : CIRAD (www.cirad.fr) - Centre de Coopération Internationale de Recherche Agronomique pour le développement

CIRAD has many years of experience in elaborating and managing R&D projects, putting together complementary and multidisciplinary competences in agriculture and production, processing and storage, distribution and marketing, to ensure the competitiveness of the whole agri-food chain, either for local and national markets or for export, thus helping LDC to face market constraints within the globalisation context. CIRAD also acts as an interface between research & academic institutes and the private sector in order to ensure better partnerships and integration of all stakeholder concerns. Food Quality and Safety is currently a high priority research topic for CIRAD through various projects dealing either with the global food quality management and risk analysis or traceability and labelling.

CIRAD has out-posted permanent scientists in Brazil for the launching and follow-up of the activities of Cirad and its partners in the Mercosur region. They have catalysing collaborations between France, the EU and the Southern Cone, through R&D projects, technical information exchange, training courses, seminars, expertise, scientific exchanges, etc, in the same topics that are addressed by this project:

Some of the main Cirad contributors have been:

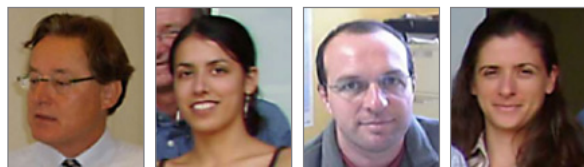

Guy
Henry

Fanny
Lange

Valery
Gond

Caroline
Blaché

Partner 3 : EMBRAPA (www.embrapa.br) - Empresa Brasileira de Pesquisa Agropecuária

The Brazilian Agricultural Research Corporation (Embrapa) has 37 research centers, three service units, and 11 central units, in almost all Brazilian states and in different ecological conditions. Three Embrapa centers have important roles in the implementation of this SSA:

Embrapa Satellite Monitoring (www.cnpm.embrapa.br) focuses on research, development, and innovation to monitor land use/land cover changes and their impacts, using orbital systems and geotechnologies that support the sustainable development of the Brazilian rural spaces and agribusiness.

Embrapa Informatics' (www.cnptia.embrapa.br) mission is to generate, adapt, and transfer knowledge, technology and bioinformatics for the sustainable development of agribusiness in Brazil. It has been engaged for more than 10 years in the development of Web-based information systems, using a myriad of programming languages (CGI, Java, Perl, PHP, C, C++, JavaScript) and Databases (MySQL, PostgreSQL, Oracle).

Embrapa Beef Cattle (www.cnpqc.embrapa.br), located in Campo Grande, Mato Grosso do Sul, has the mission of promoting competitiveness in the bovine beef chain on a sustainable basis. Its objective is to provide solutions for the increase of production and productivity, its priority being the quality of products and sub products, health, nutrition, life quality, and social equity.

Some of the main Embrapa contributors have been:



Mateus
Batistella

Anderson
Soares

Marcos
Visoli

Pedro Paulo
Pires

Thais Basso
Amaral

Sonia
Ternes

The main mission of **GAAP** (www.gaap.ulaval.ca) laboratory is to ensure the development of geomatics in different applied sectors. GAAP research activities and issues focus on the problems associated to geospatial data acquisition, treatment and diffusion. Objectives are to insure

a better use, adaptation, improvement and understanding of spatial referenced technologies as well as GPS, satellite and airborne remote sensing, image processing, GIS, optical sensors, Lidar, fluorescence, geotechnics and precision farming sensors.

GAAP has also the mandate to support the training and research program for Highly Qualified Personnel and promote the transfer of research results to industries and users.



The main mission of GAAP (www.gaap.ulaval.ca) laboratory is to ensure the development of geomatics in different applied sectors. GAAP research activities and issues focus on the problems associated to geospatial data acquisition, treatment and diffusion, territorial governance and decision making.

Alain Viau Objectives are to insure a better use, adaptation, improvement and understanding of spatial referenced data across the decisional making process to support a sustainable development of the natural resources as well as good territorial governance practices.

The research program of Dr. Viau's Laboratory is divided into five major topics: Agrifood traceability - agrometeorology - geomatic sciences, mainly linked to airborne and satellite remote sensing - precision geomatics, precision farming, - tropical geomatics and territorial governance.

Partner 5: PROCISUR (www.procisur.org) - Programa Cooperativo para el Desarrollo Tecnológico Agroalimentario y Agroindustrial del Cono Sur

The Cooperative Program for Technological Development in Agrifood and Agroindustry in the Southern Cone (PROCISUR) aims at developing a common effort of the National Institutes for Agricultural Research (INIAs) of Argentina, Bolivia, Brazil, Chile, Paraguay, Uruguay and IICA (Inter-American Institute for Agricultural Cooperation) to promote the cooperation among all the actors involved in agro-technological innovation in the region.

The goal of PROCISUR is to contribute to the building of a regional system of technological innovation, striving to provide knowledge and technology to cover the demand of the Agri-food and Agro-industrial System (AAS). PROCISUR participates in OTAG diffusion plans.

Some of the main Procisur contributors have been:



Emilio Ruz



Martín Irureta

Third Parties: Euro-Canadian Consortium

In order to complete the partnership, a **Euro-Canadian Consortium** has been established. Four bodies compose this industrial consortium and will support the OTAG project.

Agri-Traçabilité-Québec or ATQ (www.agri-tracabilite.qc.ca) aims at making a significant contribution to improve food safety through the development, implementation and operation of a permanent identification and tracing system for agricultural products, both for animal and crop productions.

Financière Agricole du Québec (FADQ) is the agency in Québec responsible for managing financial tools for agricultural needs. Its mission is to support and encourage the development of the agricultural and agri-food sector within a perspective of sustainable development. For instance, FADQ has introduced a new way to measure insured fields, that is, by way of aerial photographs and new information technologies, as well as geomatics.

Syscan International Inc. (www.syscan.com) is a unique chain solution supplier delivering integrated real time tracking and tracing solutions that improve business efficiency through radio frequency identification (RFID).

Allflex, (www.allflex.com.br; www.allflex-europe.com; www.allflex.com.au; www.allflex.co.uk) is the Global Leader in Livestock Identification and Bovine Traceability solutions. Allflex has sites in UK, Australia, New Zealand, USA, China, Brazil and France, with distribution offices worldwide. The philosophy embraces innovation - providing customers a clear advantage today and in the future. Its innovations include the Allflex Global Tag with guaranteed permanent Laser-Ink Marking, Electronic (Radio Frequency) Identification Systems, Custom Laser-Marked Visual Identification Tag, Allflex Ultra Tag with high retention, Allflex range of electronic Sheep Tags, Electronic Identification Systems (based on Radio Frequency technology, ISO 11784/11785 standards), Permanently fixed and Handheld Data Collection devices.

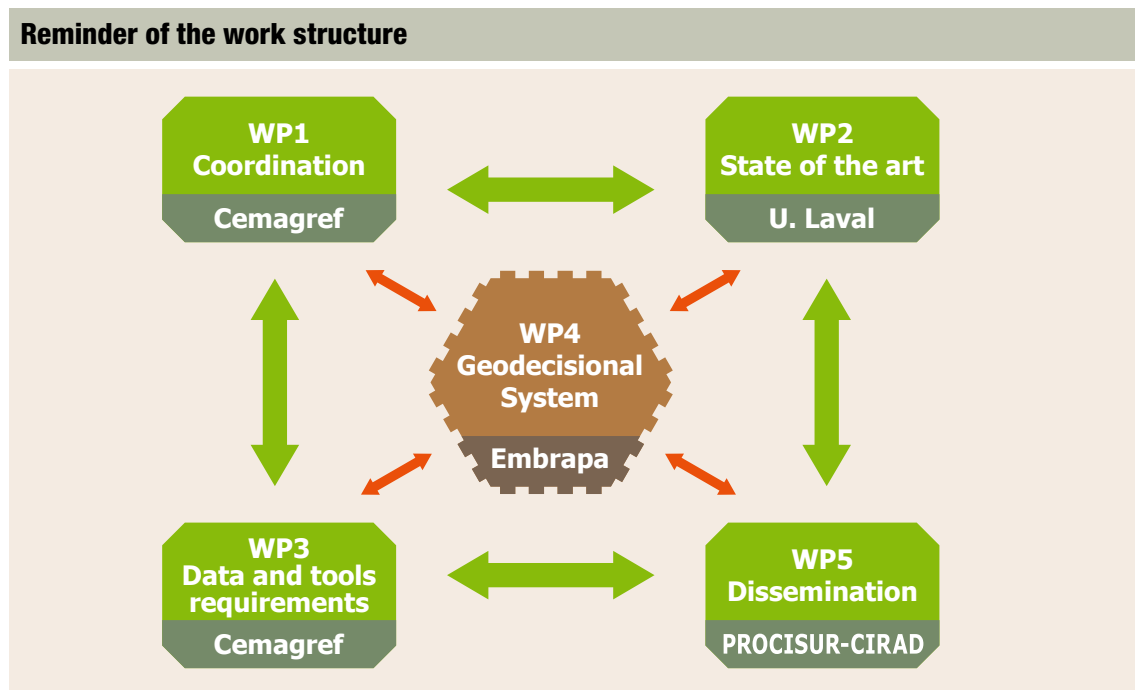

Main objectives and results of WP1 - Coordination:

- To provide the administrative and financial management of the whole project.
- To provide strong management and monitoring of all the work undertaken during the project.

Main objectives and results of WP2 - *State of the art and technology watch*

- To identify opportunities and research gaps related to geodecisional tools used to manage risk and crisis events in beef production within the context of Southern Cone Countries and EU policies.
- Run an accurate State of the Art in different Countries, collecting relevant information from any concerned field (regulation, research, standard, technology, ...).

Main objectives and results of WP3 - *Data and tools requirements*

- To identify the best practices requirements to track and trace emerging risks in beef production specifications in Southern Cone Countries and to rank priorities for suitable geodecisional systems.
- To define the requirements for data collection, integration, architecture and system interoperability.
- To adapt existing operational tools for OTAG System and to design the protocols and proof of concept of OTAG System.

Main objectives and results of WP4 - *Operational geodecisional prototype*

- To design and implement the operational geodecisional prototype system:
- To set-up procedures and outlines, define the methodology and tools for the prototype, ensuring that it will be operational (under control condition – Campo-Grande).
- To set-up the demonstrator for the case study.
- To assess the technical specifications for the information system structure and function (architecture, analysis and processing functions, data integration...).
- To design this information system and its use possibilities.

Main objectives and results of WP5 - *Dissemination and improvement of the OTAG Concept*

- To broadcast results of the project, its ongoing work and outputs.
- To manage a broadcast plan (including meetings and workshops), publications and diffusion on the Website, communication to the public and private sector, the scientific community, ...

Part 2

State of the art:

*Traceability in Europe,
Quebec and Southern
Cone countries*

Laws, rules and regulations on traceability

Writing coordinated by Fanny Lange, CIRAD

A. Animal welfare

The Treaty of Amsterdam, in force since May 1st, 1999 lays out new ground rules for the actions of the European Union (EU) on animal welfare in a special “Protocol on the Protection and Welfare of Animals”. It recognises that animals are sentient beings and obliges European Institutions to pay full attention to the welfare requirements of animals when formulating and implementing Community legislation. The protocol establishes the responsibility of the EU to legislate with an aim to improve the welfare of animals and prevent cruelty against and mistreating of animals in areas covered by the Treaty (such as agriculture).

“The new Treaty establishing a Constitution for Europe, signed on October 29th, 2004 by the Heads of State or Government of the 25 Member States and the 3 acceding and candidate countries, also sets forth the commitment to ensure the protection of animals. Article III 121 provides that the Union and Member States shall fully consider the requirements of animal welfare in formulating and implementing the Union’s agriculture, fisheries, transport, internal market, research and technological development and space policies. This will be done while respecting the legislative or administrative provisions and customs of Member States particularly related to religious rites, cultural traditions and religious heritage.”

Animal welfare on the farm

In 1998, Council Directive 98/58/EC on the protection of animals kept for farming purposes issued general rules for the protection of animals of all species kept for the production of food, wool, skin or fur or for other farming purposes, including fish, reptiles or amphibians. These rules are based on the European Convention for the Protection of Animals kept for Farming Purposes. They reflect the so-called ‘Five Freedoms’ as adopted by the Farm Animal Welfare Council:

- Freedom from hunger and thirst - access to fresh water and a diet for full health and vigour,
- Freedom from discomfort - an appropriate environment with shelter and comfortable rest area,
- Freedom from pain, injury and disease - prevention or rapid treatment,
- Freedom to express normal behaviour - adequate space and facilities, company of the animal’s own kind,
- Freedom from fear and distress - conditions and treatment which avoid mental sufferings.

Community legislation concerning the welfare conditions of farm animals lays down minimum standards. National governments may adopt more stringent rules provided they are compatible with the provisions of the Treaty.

Animal welfare during transport

The European Commission welcomes the adoption by the Council on November 22nd, 2004 of a Regulation on the protection of animals during transport, which will help to safeguard animal welfare by radically improving the enforcement of animal transport rules in the EU. The Regulation amounts to a radical overhaul of the existing EU rules on animal transport and it identifies the chain of all those involved in animal transport, defining “who is responsible for what” thus facilitating more effective enforcement of the new rules. The Regulation introduces new and more efficient monitoring tools such as checks on vehicles via a satellite navigation system as of 2007. It also introduces much stricter rules for journeys of more than 8 hours, including a substantial upgrading of vehicle standards.

According to Regulation (EC) No. 1/2005 on the protection of animals during transport and related operations, satellite navigation systems will become obligatory in road vehicles transporting livestock over 8 hours. For newly built vehicles, it will become obligatory as of January 2007 and for all vehicles as of January 2009.

Animal welfare at slaughter

EU legislation on slaughtering practices aims to minimize the pain and suffering of animals through the use of properly approved stunning and killing methods, based on scientific knowledge and practical experience. The first Council Directive 74/577/EC on stunning animals before slaughter was replaced in 1993 by Council Directive 93/119/EEC covering a wider range of animals and slaughter circumstances.

B. Animal identification

The basic objectives for Community rules on the identification of bovine animals are

- the localisation and tracing of animals for veterinary purposes, which is of crucial importance for the control of infectious diseases,
- the traceability of beef for public health reasons,
- the management and supervision of livestock premiums as part of the common organisation of the market in beef and veal.

The system for the identification and registration of individual bovine animals includes the following elements:

- double ear tags for each animal, with an individual number
- maintaining a register on each holding (farm, market etc.)
- cattle-passports
- a computerized database at national level

The models of ear tags, passports and holding registers, which are used in the different Member States, can be found at:

http://ec.europa.eu/food/animal/identification/bovine/id_bovine_animals_en.htm

C. Food production and traceability

For consumers, safety is the most important ingredient of their food. Recent crises have undermined public confidence in the capacity of the food industry and of public authorities to ensure that food is safe. The European Commission has identified food safety as one of its top priorities. The White Paper on Food Safety of January 12, 2000 sets out the plans for a proactive new food policy: modernizing legislation into a coherent and transparent set of rules, reinforcing controls from the farm to the table and increasing the capability of the scientific advice system, so as to guarantee a high level of human health and consumer protection.

The **Strategic Priorities** of the White Paper are:

- to create a European Food Safety Authority
- to consistently implement a farm-to-table approach in food legislation
- to establish the principle that feed and food operators have primary responsibility for food safety; that *Member States* need to ensure surveillance and control of these operators; that the *Commission* shall test the performance of Member States' control capacities and capabilities through audits and inspections

On January 28th, 2002 the European Parliament and the Council adopted Regulation (EC)178/2002 laying down the General Principles and requirements of Food Law. The aim of the General Food Law Regulation is to provide a framework to ensure a coherent approach in the development of food legislation. At the same time, it provides the general framework for those areas not covered by specific harmonized rules but where the functioning of the Internal Market is ensured by mutual recognition. It lays down definitions, principles and obligations covering all stages of food/feed production and distribution.

The General Principles of Food Law (Articles 5 to 10) entered into force on 21 February 2002 and must be followed when measures are taken. Existing food law principles and procedures must be adapted by January 1st, 2007 in order to comply with the general framework established by Regulation EC/178/2002.

The food law aims at ensuring a high level of protection of human life and health, taking into account the protection of animal health and welfare, plant health and the environment. This

integrated “farm to fork” approach is now considered a general principle for EU food safety policy. Food law, both at national and EU level, establishes the rights of consumers to safe food and to accurate and honest information. The EU food law aims at harmonizing existing national requirements in order to ensure the free circulation of food and feed in the EU. The food law recognizes the EU’s commitment to its international obligations and will be developed and adapted considering international standards, except where this might undermine the high level of consumer protection pursued by the EU.

To complete this section it is important to read state of the art reports produced for OTAG presenting the situation for France and Quebec as well as for Brazil (These study reports are available on the OTAG public WEB site (<http://www.otag-project.org/>)).

OTAG Quebec Research Contribution¹

Dr Alain A. Viau, Laval University

The expertise of the Laboratory GAAP at Laval University was focused on Applied and Agricultural Geomatics. It started its research activities related to Traceability issues in 1998. An important research work carried out was one on the development of the GeoTraceability (GTA) concept:

http://www.geotraceagri.net/doc/GeoTraceAgri_Finalreport_EN.pdf

A good traceability system for agri-food products must include user/partner identification, premises identification, product identification and movement follow-up.

Traceability is currently a very hot topic. It is the “aptitude to find the history, the use or the localization of an entity by means of recorded identifications” (ISO8402). In other words, traceability is the creation of a tracking system (<http://www.can-trace.org / LEARNMORE/ FAQ/tabid/98/language/en-US/Default.aspx>; <http://www.agri-tracabilite.qc.ca>), for all stages of production, from the origin of the product to the end product, which can be used as a benchmark to ensure the origin and quality of the product in order to guarantee that it is safe for consumer consumption. Consumers are more and more concerned about the quality and safety of the food they buy, as it has been clearly demonstrated during the recent crisis that affected the agri-food industry (<http://www.agri-tracabilite.qc.ca/documents/cfm-feb08.pdf>).

The EU food legislation (payments 178/2002, 852/2004, 183/2005, 853/2005) has played an important role by redefining obligations of traceability on the whole agri-food chain, not only in European Country but also worldwide.

ATQ research and assessment projects associated to OTAG (2005-2009)

The following section presents the synthesis of Agri-Traçabilité Québec’s contribution (cf. “ATQ Annual Report” - <http://www.agri-tracabilite.qc.ca/>). ATQ developed a service offer that not only is interesting for potential customers but is also adaptable to various needs, whether a complete traceability system is required, a software license or personalised services. Furthermore, a new independent organisation is being set up, Agri-Traçabilité International (ATI - <http://www.traceability.ca/index.html>), whose mandate is to promote Quebec expertise in terms of permanent identification and traceability.

¹ The following content is a textual transcription from the ATQ activities reports, FADQ reports as well as research studies reports related to OTAG research activities (<http://www.agri-tracabilite.qc.ca/en/publications-atq-others.html> - <http://www.fadq.qc.ca/index.php?id=914&L=1> - <http://www4.agr.gc.ca/AAFC-AAC/display-afficher.do?id=1244051104062&lang=eng>). The content of this summary integer ATQ and FADQ contributions and present the state of the art in traceability for Quebec.

ATQ was established to develop, implant and maintain an information system allowing to:

- a. Limit and rapidly eliminate potential crises by reacting quickly to problems related to animal disease and food safety;
- b. Retrace all identified animals to their herd of origin and know their histories, their movements, and their present locations;
- c. Improve diagnostic and checking capabilities thus reducing the risks associated with the export and import of livestock;
- d. Regroup production activities occurring at the same place in a single database to achieve traceability from the farm to the table for all types of agricultural productions;
- e. Negotiate partnerships for information exchange between stakeholders in the agrifood sector;
- f. Standardise applications between the different regulated agricultural productions.

1- FDX tag assessment

Some FDX tags, approved by CCIA, offer an alternative to HDX tags for the beef and the dairy industries. Reading tests will be conducted at strategic key premises with live animals, as well as resistance tests (ageing and breaking strength), held in CRIQ laboratory.

2- Bovine Tag Retention : Long Term Assessment

In cooperation with the Allflex Company, a rigorous follow-up project has been undertaken. Visits will be made once or twice a year to about 20 beef and dairy farms. The project will provide a statistical analysis of the on-farm rate of ear tag loss. Also, a neutral body will perform laboratory tests on the resistance of the tag materials.

3-Live Animal Transport

The goal of this project is to develop turnkey solutions adapted for the livestock transportation sector, that will allow for the automated collection and transfer into the ATQ database of traceability-related information. The Solutions for Transport Traceability is comprised of RFID readers, pocket computers with the TransTraq software installed, and portable printers.

4- Live Animal Transport - Information transfer section

The project is aimed at the transfer of information using the Solutions for Transport Traceability at strategic points (auctions and abattoirs) following the transportation and unloading of livestock (beef, sheep, pork). Project partially funded by Agriculture and AgriFood Canada through the Canadian Integrated Traceability Program.

5- Live Animal Transport - Lots section

This project has as its main objective to adapt the Solutions for Transport Traceability for ani-

mals with an individual identification (beef and sheep) to the practicalities of identification by lot (pork, poultry). Project partially funded by Agriculture and AgriFood Canada through the Canadian Integrated Traceability Program.

6- Evaluation of equipment functionality

Producers through field trials of a hand-held electronic system and a targeted information campaign aim this project at improving automated equipment for the collection and transfer of traceability information and its uptake. Project partially funded by Agriculture and AgriFood Canada through the Canadian Integrated Traceability Program.

7- Table Eggs Traceability

Project objectives are to set up a single identification and traceability system for light breed bird lots in Quebec's table eggs industry as well as to provide a single identification system from the farm to the table for the eggs produced, graded and marketed by the producers enrolled in the quality assurance program.

8- Sheep RFID tags comparison

Two years after the implantation of the traceability system in the sheep sector, sheep and lamb producers have judged it pertinent to try new identifiers. In January 2006, a pilot project was begun to evaluate two new types of identifying tags.

9- Bovine Tag Retention: Loose Housing

Following the comprehensive identification of beef livestock, a certain number of on-farm verifications were done, as a follow-up to the pilot project done in 2003. A second pilot project was undertaken, this time looking at ear tag retention in loose housing conditions (6 dairy farms and 2 beef farms). Results: 84.95 % of the 831 dropped tags originate from the comprehensive identification operation.

10- RFID and Cervidae traceability

The pilot project on cervidae permanent identification and traceability ended in December 2005. More than 5300 animals have been identified in the premises of 14 wapiti breeders, 12 red deer breeders, and 2 white-tailed deer breeders.

11- Bovine Tags Retention : Stall Housing

Willing to continue improving the existing system, Agri-Traçabilité Québec, with the participation of the PATLQ, the Quebec Artificial Breeding Centre, Holstein Canada and the tags provider, has set up a tag retention committee.

Brazilian Traceability System (SISBOV)²

Dr. Pedro Paulo Pires and Thaís Basso Amaral, Embrapa

Brazil counts, since January 2002, with a tracking system for bovines called System of Identification and Certification of Origin for Bovines and Buffaloes (SISBOV). This traceability system consists of a set of norms and procedures defined by the Ministry of Agriculture, Livestock and Supply (MAPA) with the purpose of identifying, registering and monitoring, individually, all bovines and buffaloes born in Brazil, or imported, so as to determine their origin, production and productivity of livestock, their sanitary status, and the security of animal by-products.

SISBOV was instituted by the Normative Instruction 1, of January 9th, 2002 and regulated by the Normative Instruction 23 of the Animal Defense Secretary of MAPA, dated February 2002. Since April 6th, 2004, SIBOV has been regulated by new operational norms and procedures of animal traceability and identification. Changes were determined by Normative Instruction 21 to facilitate operation, standardise the identification seal, help fight eliminating diseases, increase participation of states and keep track of animals from the age of 40 days onwards. At last, the final text of Normative Instruction 17, published on July 14th, 2006, established a new different structure.

Enrollment in the new system is voluntary; however it continues to be mandatory for commercialisation in markets requiring traceability. With Normative Instruction 17, the Rural Establishment Approved by SISBOV (ERAS) emerges, establishing the following main requirements:

- Registration of producer
- Registration of property
- Basic Production Protocol
- Terms of enrollment in SISBOV
- Registration of raw materials used in the premises
- Individual identification of 100% of bovines and buffaloes within the property
- Animal movement traceability
- Supervision of the Certifying Body licensed by the Ministry of Agriculture, Livestock and Supply (MAPA)
- Periodic inspections by the Certifying Body

² http://www.agricultura.gov.br/pls/portal/docs/PAGE/MAPA/MENU_LATERAL/AGRICULTURA_PECUARIA/SISTEMAS_INFORMATIZADOS/SISBOV_NOVO/IN17.PDF

According to the new rules, it will be mandatory for all bovines and buffaloes in rural premises approved by SISBOV to be individually identified and registered in the SISBOV database, including raw materials used in the premises during the production process.

It is a major progress considering that from 2009 onwards only bovines and buffaloes will be to enter approved rural premises provided they originate at premises also operating under the same SISBOV regulations. The system will allow information to be updated by Agencies Executors of the Animal Health in the states and by the Certifying Agency of the Rural Establishment approved by SISBOV, certified by MAPA.

Use of technological tools

According to the new regulations, the seal on the ear device has a new format. It shows the SISBOV watermark, it is printed with the standard official seal, and has a new 15- digit code. The former code had 17 digits which could also identify the originating micro region of the animal. The new seal identifies the originating country of the animal (3 digits) and the originating state (2 digits) in addition to a set of nine digits for the bovine or buffalo's identification and a one-digit identification code.

According to requirements established by MAPA, when an animal is certified by SISBOV, it receives a document called "Certificate of Origin" or "Document of Animal Identification" (DIA), and a device with the SISBOV number showing the origin of the bovine individually registered on the database. The certificate accompanies the animal all its life, from birth to slaughter, natural or accidental death, and keeps track of every movement of the animal resulting from transfers or emergency sacrifice. The DIA must indicate that the animal originates from a legally established rural property and that it is registered on the SISBOV-MAPA national database.

In order for the SISBOV Certificate to be authorised, the producer must provide evidence stating that the system of production, sanitary programs and characteristics of the rural property are in accordance with the specifications defined by SISBOV regulations and requirements.

One advantage of the new system is the resistance of the identifying device, which the animal bears all its life. The new regulations are also aimed at creating dual identification, chosen from the following four options:

- an auricular device on the right ear and a button (2.6 to 3 cm long) on the left ear, with a 6 digit SISBOV identification number (from the 9th to the 14th SISBOV number);
- an auricular device on the right ear and an electronic device;
- an auricular device on the right ear and a tattoo on the left ear with a SISBOV identification number;
- an auricular device on the right ear and a SISBOV identification number marked with hot iron on the right leg. The six-digit identification number must be marked in two sets of three digits, the first set being placed on an imaginary line and the other set right below.

The dual animal identification, created with the mandatory use of the right ear device and a chosen identification mode, in addition to the information registered on the database, allow for the auditing of the system.

Application of the Normative Instruction

The Normative Instruction is applicable nation-wide to rural cattle breeding premises, packing plants producing bone products, by-products and residues of high economic value, and certifying companies accredited by MAPA.

State and private control mechanism

SISBOV operational control is made through an official National Database. This database contains updated information on animals, rural and agro industrial properties; all of them are identified and registered on SISBOV by accredited entities.

The monitoring of premises is the responsibility of the certifying agencies that define the computerised system of registration maintained by the establishments. The role of the certifying agencies consists of:

- Circulation registration and control, and management of reproduction, nutrition and sanitary issues (vaccine, tests and treatments) of livestock.
- Registration of the inflow, outflow and use of basic materials at the premises.
- Animal identification by the Animal Identification Document (DIA). It is mandatory that all bovines and buffaloes born in identified herds are included in the program.

Re-identification

In case the identification gets lost, the Certifying Entity is able to proceed with the requested re-identification keeping records of the sequence of events.

The Argentinean Traceability System³

Fanny Lange, Cirad

In Argentina, since the year 2003, a system of individual animal identification and management was adopted and used for traceability. This system will reinforce group identification thanks to tattoos already used for cattle. The system was developed with the objective of complying with European Union demands, considering the importance of that market and its significance in its contribution to the value chain. We understand that traceability is a tool that, by means of suitable cattle identification, contributes to the improvement of information on stock and to a useful knowledge of the dynamics of national livestock, allowing to improve the national sanitary system as well as to control commercial aspects. Although the individual identification system was conceived for cattle intended to be exported, it has been decided to expand the system to the whole national herd, from the individualisation of new-born calves -which will progressively be incorporated as of the year 2007, until full replacement and identification.

Animal identification is unique, not re-usable, and the animal bears it from the first movement to the last. Identification is done by means of an inviolable “button-button”-type ear tag and a unique alphanumeric 9-digit code.

³ PROCISUR, Instituto Interamericano de Cooperación para la Agricultura. Estado actual de los sistemas de trazabilidad para bovinos de carne en los países del Cono Sur. 2nda edición, Montevideo, Uruguay, Noviembre 2006.

Part 3

*Data and
tool requirements*



OTAG information system

M. Visoli, S. Ternes – Embrapa; J.P. Chanet, F. Pinet, S. Bernard
G. De Souza, A. Miralles – Cemagref

Information flow

The computational architecture proposed for the OTAG prototype is organized in four layers (see Figure 1). Layer 1 involves the collection of data from electronic devices in the paddock. Animals have a collar with a GPS device and the paddock has sensors for the automatic collection of weight and vaccination registers, and temperature measurements for each animal, among others. The information produced for the electronic devices is sent to a computer located in the farm headquarters. For this task, we intend to use the open standard XML, making it possible to use electronic devices of any manufacturers. In fact, the definition and improvement of a standard that can be used by any manufacturer is one of the challenges posed by the OTAG Project. Layer 2 is responsible for storing data which is sent by the electronic devices and associated with farm management data. The user interface of this layer will allow the farmer to manage data and draw out reports on his cattle production on the Internet. The data of each farm will be sent to Layer 3 using web-service technology. On Layer 3 the information of all the farms of the OTAG system is combined on the same database. Thus, information related to animal movements within the farm and between farms can be analysed through the use of techniques to manage geo-referenced information. The last layer is responsible of managing the data from the OTAG database and from external databases (soil, pastures, climate), and combine it in a specific database to allow geo-decisional analyses.

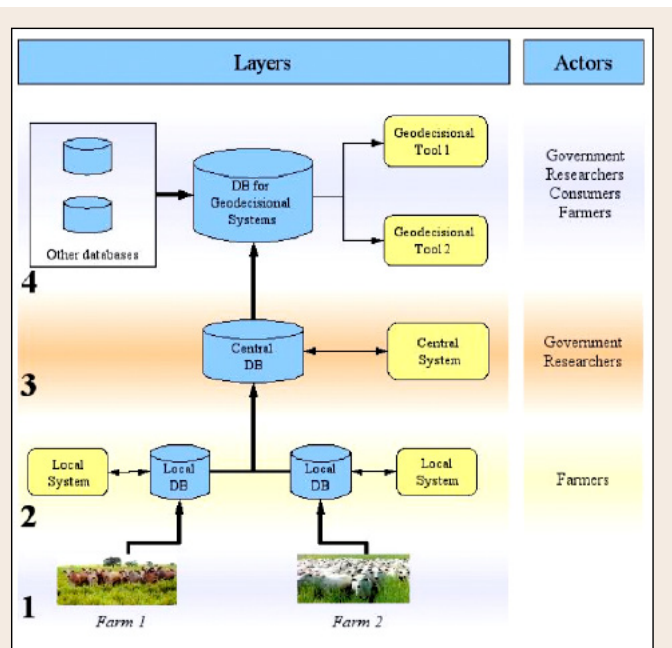

Figure 1: Computational architecture of the OTAG prototype

OTAG system actors will be responsible for the input of data and they will also get information from the system in order to make decisions regarding farm production. This information may be accessed according to each actor's profile. The possible actors are described herein below.

Actors

OTAG system actors will be responsible for the input of data and they will also get information from the system in order to make decisions regarding farm production. This information may be accessed according to each actor's profile. The possible actors are described herein below.

Government

Data on animal circulation can generate information useful for decision making to be applied in simulations of real life, such as:

1. in case of an outbreak of foot-and-mouth disease, to identify the location of all the animals that had contact with an infected animal during a certain period of time before outbreak identification. This procedure allows to better invest human resources, in order to control and create a blocked area around the potential focus;
2. through the identification of a large amount of movement of animals from a specific geographical point, it is possible to implement actions to minimize movements or increase control of movements in that region;
3. identification of proper sites to implant new processing units, reducing animal movement between regions and, as a consequence, minimizing the risk of contamination in case of disease.

Consumers

Consumers represent external and domestic bovine meat markets. The OTAG system can provide information to those actors on production system practices and animal lives, origin, sex, feeding type, etc. This data contributes to increase product quality and reliability.

Researchers

Researchers are able to get plenty of information from the OTAG system, for different objectives such as:

1. compare results of the different production systems being used in the farms;
2. based on the data that will be integrated, such as on soil, pastures and climate, it is possible to cross data from those databases to extract new information about the real impact of these factors on the beef cattle production systems;
3. analyse in a more realistic way the relation between animal movements and occurrence of diseases.

Farmers

Farmers are the most important actors in the OTAG system. The quality of the information they supply directly depends on the benefits they may obtain from the use of the OTAG system, as well on the electronic devices implanted in their farms. Farmers may obtain information to:

1. obtain a better control of their animal production, being able to implant traceability of production processes;
2. receive comparative information about their production system in relation to other farms using similar systems;
3. receive news about possible outbreaks in certain regions, in order to avoid trading with animals from these regions.

Technological platform

The technological framework to be used in the development of the local system is: Java 2 Enterprise Edition Platform, IDE Eclipse, PostgreSQL and PostGIS as database systems with geographical support, Hibernate tool as the persistence layer, Java Server Faces for interface design and control, Apache web server and Jakarta Tomcat application server.

During the construction of the OTAG system the need of new tools will be identified, mainly related to geo-decision. The use of multi-platform and open-source software is an essential condition for the OTAG project. The open source allows to study and adapt the software for specific project needs. Moreover, it allows for the technological autonomy of the partners to the project. Multi-platform is an essential requirement not only because partner institutions have distinct operational system platforms, but also because it makes it possible to implement the OTAG system in other interested institutions and distinct actors.

The use of tools for receiving, treating and organizing a great amount of data is also necessary to obtain an acceptable response time for the reports and queries demanded by final users. With this aim, we intend to analyse the use of business intelligence tools and also Spatial OLAP technology. The possibility of integration with external databases is also foreseen. This can contribute to a better analysis for decision making regarding farm production. For instance, the integration of the OTAG prototype with databases on soil, pastures and climate can increase the quality of the information concerning beef cattle production.

UML Model

The model that describes the data of the OTAG local system has been formalized with the Unified Modelling Language (UML). We advocate the use of UML in the model of the OTAG System. We consider this type of formal representation as the best means to precisely describe the data managed by the OTAG local system. The model has been built interactively upon different meetings and discussions held between the various researchers involved in the project.

UML is issued from the unification of several formal object-oriented methods existing during the 90s. It is now considered as a standard for modelling computational systems. More precisely, UML is a graphical language for visualizing, specifying and constructing any parts of computer-based components. It is used successfully in information system and object-oriented developments. At present, UML is the common way to represent information systems.

In the proposed class diagram describing the OTAG model, each concept is represented by a class. The main class' attributes have been specified on the diagram. Hierarchies are used to model the nomenclatures of concepts; they are represented in UML using the generalisation/specialisation relationship. This gives more flexibility to the model, providing the possibility of adding more precisions about concepts later.

OTAG local system is based on some concepts like farm, framer, cattle exploration, paddock, animal, sanitary event and geo-position. These concepts come from some practices of Brazilian beef cattle production systems.

The farm is an agricultural establishment that belongs to one owner. On it there must be some cattle explorations, each one under the responsibility of a farmer that can be the owner or a lease-

holder. Each cattle exploration corresponds to a physical area, with one specific production system, that can be changed periodically. Cattle exploration is divided into paddocks where animals of one determined type are raised. The paddock is characterised by a feeding system that can be modified throughout time. There is a batch of animals per paddock. A batch can be moved from one paddock to another. The animals periodically receive some vaccines (sanitary aspect), they undergo different types of handling, where weight, temperature, etc. can be measured. Moreover, each animal is subject to the occurrence of certain events such as birth, death, entrance to and exit from the farm. Animal geo-localisation (positioning) will be measured periodically, through the use of a collar on each animal, considering the 'master/slave' concept. The animal wearing the master collar will capture periodically, during a specific handling operation, the identification of the slave collars of all the animals around it. Then the master collar will send a UHF signal to a receiving base such as: the localisation measured by the GPS on the master collar, the list of animals around it and information about the handling operation. The receiving base will send this data by WiFi to a computer at the farm headquarters.

Based on the general foregoing description, the UML model of the OTAG local system was developed using Objecteering Software, which automatically generates the model's documentation in HTML format. We present below a general description of the packages and classes. Associations between packages are presented in Figure 1. Figure 3 also presents the details of the animal package.

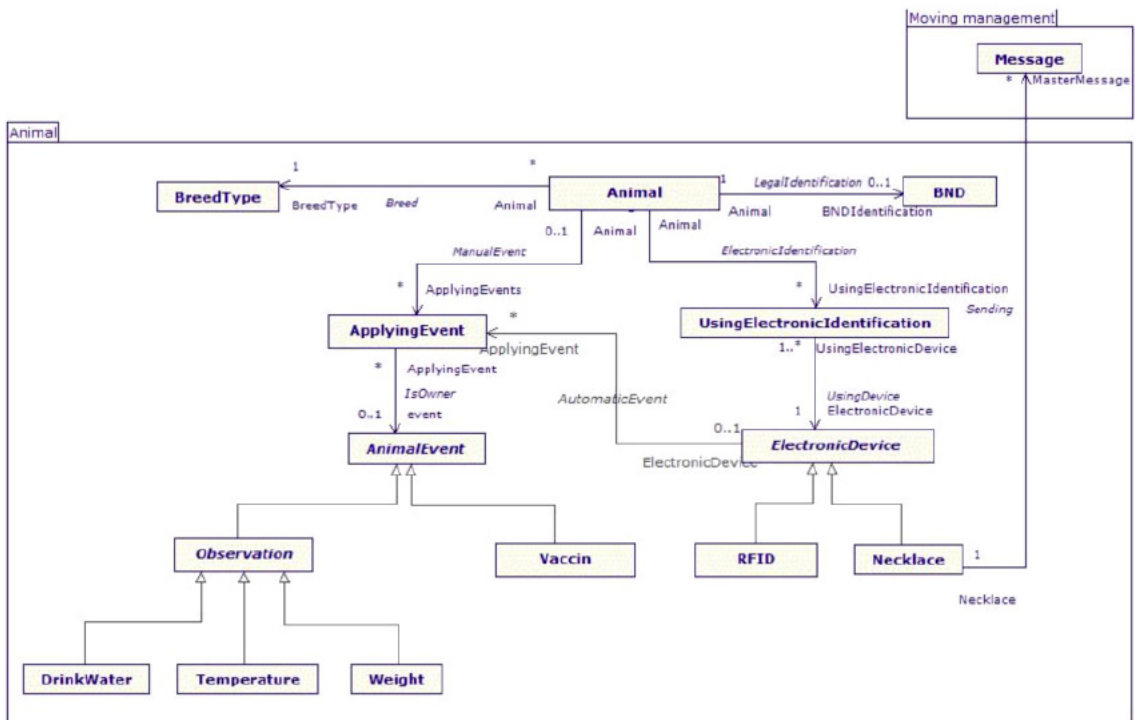

Development of electronic collars to track and trace cattle⁴

One of the objectives of the OTAG project is to track the circulation of animals in natural and extended environments. This objective implies the availability of adapted technologies in order to estimate the positions of animals (considering a desired precision and acquisition period), and to store and make this information available to the operational geo-decisional system.

In order to reach this objective, an initial strategy was described in the OTAG project proposal. This initial so-called ‘master-slave’ approach, defines sub-groups within the herd, associated with a reference animal (the ‘master’, equipped with a GPS-based collar). A decisional polygon is defined around each ‘master’, and all the other animals located inside this polygon are considered as ‘slaves’. The master identifies the slaves through the use of a communication system.

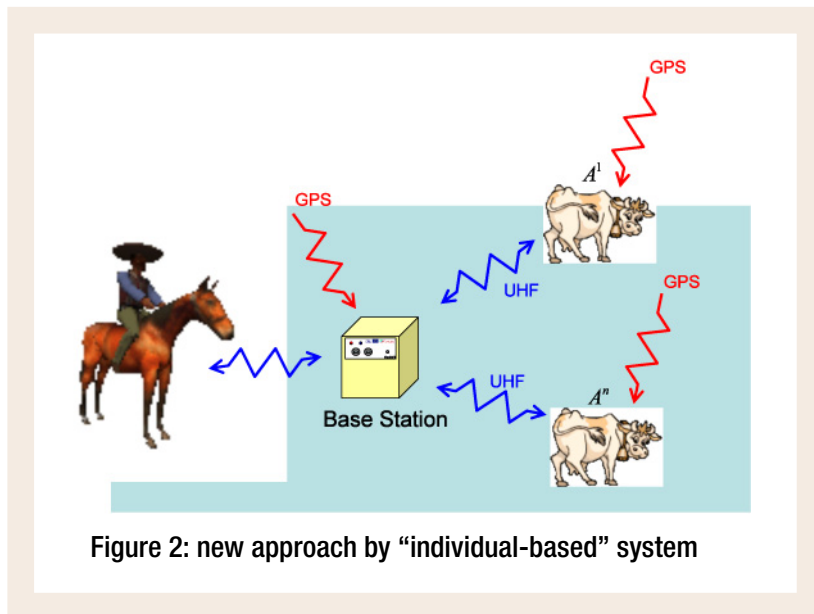

Mainly due to problems related to communication aspects, we have selected and developed a second strategy called “individual-based” approach: all animals are equipped with a GPS-based collar, which measures the position of the animal with a predefined frequency. The GPS positions are periodically transferred to a base station in order to be collected and used by the management system. Electronic collars and base stations are presented in Figure 2.

Two different elements (hardware and software) have been developed for the OTAG project to track and trace cattle:

⁴ P. Faure, P. Rameau, M. O. Monod, L. Moiroux- Cemagref

- *Electronic collars* - A collar is placed on every animal, which uses an internal GPS to measure its position through a predefined frequency. Then the GPS data is transferred to a base station
- *Base Station* - The base station is the second developed element. The role of the base station is to collect the GPS data from all collars and make them available to an operator.

These two elements communicate with a UHF communication system and use a dedicated communication protocol.

Electronic collars

Figure 3 presents the general architecture of electronic collars.

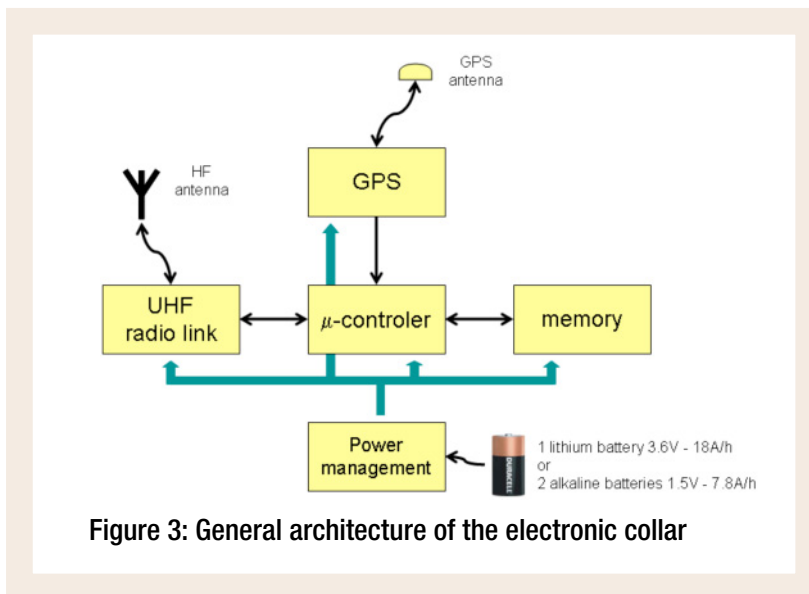

The main elements of this device are:

- GPS and its antenna to measure the position of the animal
- UHF system to communicate with the base station
- a memory to store GPS data before it is transferred to the base station
- a micro-controller which manages the overall functioning of the collar
- the last element is the management of the power supply in order to have the lowest possible power consumption

Figure 4 presents a prototype of the collar with its two main elements:

- a black box where the electronic parts are placed,
- a belt where the GPS antenna is integrated.

The antenna is placed outside the black box, at the top of the collar, in order to obtain a good reception from the GPS satellite. Figure 5 shows the antenna and the coaxial cable which are sewn inside the leather collar for protection.



Figure 4: General view of the electronic collar

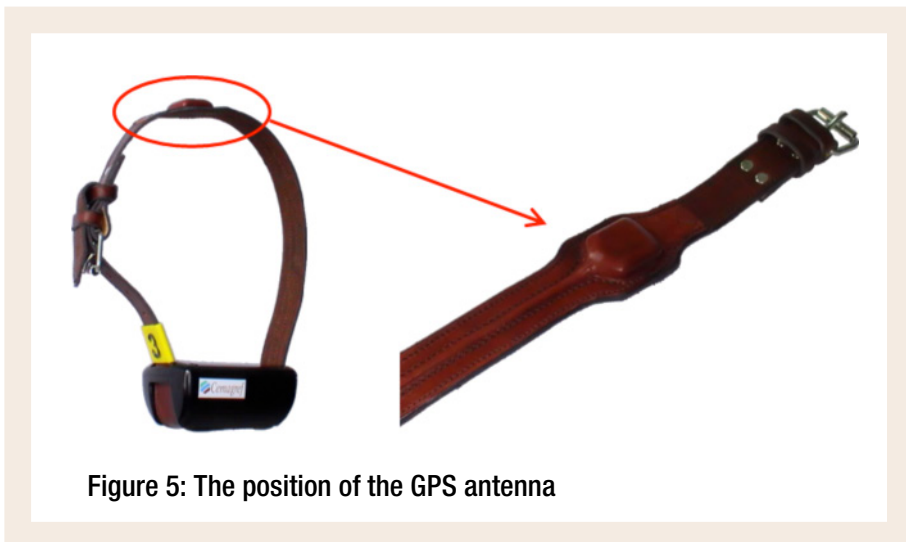

Figure 5: The position of the GPS antenna

Power supply management

Energy consumption is a very important aspect for the autonomy of the equipment and numerous studies have been performed on this topic. Particularly, the necessary energy to read, store and transfer GPS data has been estimated considering:

- the different electronic elements in the collar (GPS, UHF system, micro-controller),
- the internal software managing these elements,
- the sampling period of the GPS data which constitutes significant parameter.

It is then possible to study how the energy of the battery is used in the collar. This is the result obtained with the first prototype of the collar (it is the collar we have used during the demonstration yesterday). The chart represents all the energy of the battery inside the collar. Simulations have been done in order to estimate the distribution of the energy between all the elements as a function of the sampling period: i)~for a sampling period of five minutes, the GPS is the biggest energy-consuming device, the UHF and the micro-controller have similar energy consumption levels; ii)~when the sampling period increases, GPS consumption decreases (as well as UHF consumption). And finally, for long sampling periods, the micro-controller is the biggest energy-consuming device (see Figure 6).

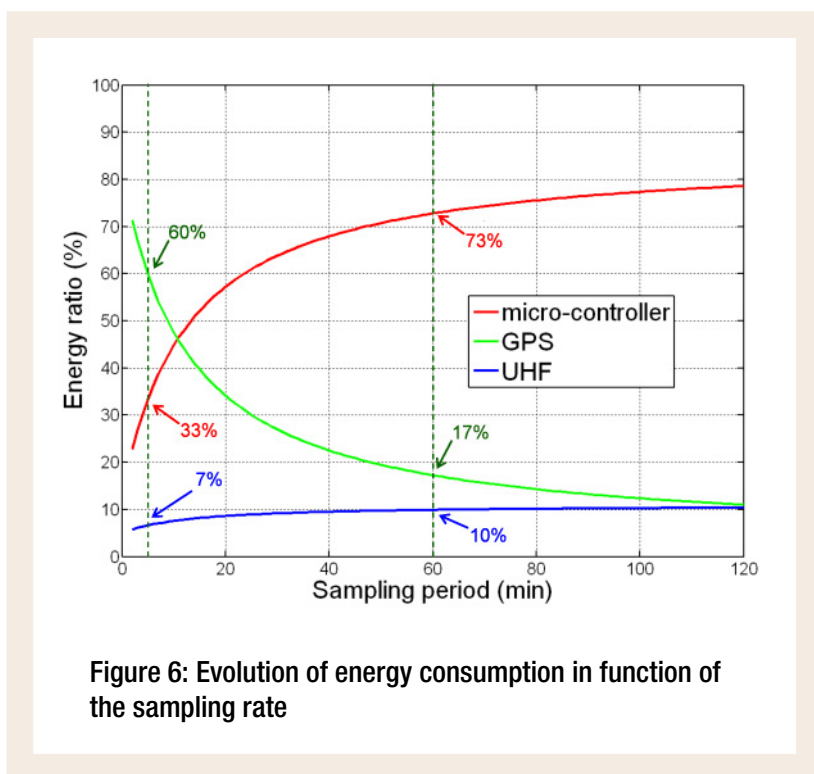

According to simulations, the lifetime of the collars could be estimated in function of the sampling rate. Simulation results show that for a sampling rate of one acquisition per hour, the lifetime of the collar would be of around 1 year.

Base station

The second element developed is the base station (see Figure 7). The housing used is that of an electric fence generator developed by LACME Company. A solar panel is also used in order to increase energy autonomy of the base station.

The general architecture of the base station, presented in Figure 8 is as follows:

- the whole system is based on a PC with a Microsoft Windows operating system. It is a one hundred and four (104) PC, because the computer is small; it is a low energy-consuming system because this kind of computer functions within a large range of temperatures (positive and negative);
- a GPS and its antenna to measure the position of the base station;
- the UHF system to communicate with the collars;
- a power management system controls the supply of the whole base station using a battery and a solar panel;
- we are not using screen and keyboard to control the PC because these interfaces are not adapted to the outdoor environment. Instead we are using a touch-sensitive screen which is connected to the Ethernet network;
- and a USB connector to allow the operator to collect all data from the collars, which is stored in the PC memory.



Figure 7: General view of the base station

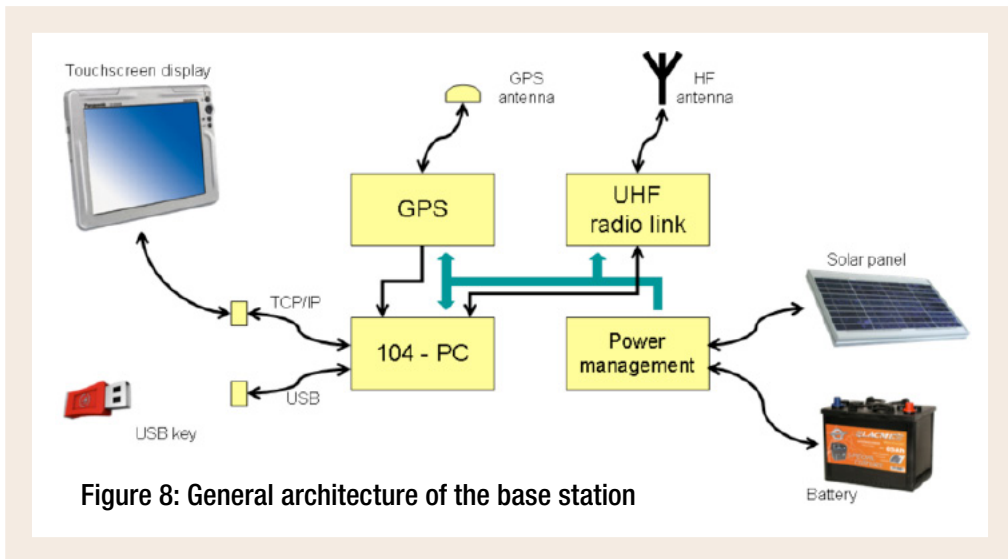

Figure 8: General architecture of the base station

Base station software development

The last point concerns the different kinds of software that have been developed for the base station. The objective of this software is:

- to read the GPS data from all collars
- to save this data in identified files
- and to make these files available to the operator

A graphic interface has been developed which integrates these algorithms in order to show and explain the whole functioning of the system (see Figure 9).

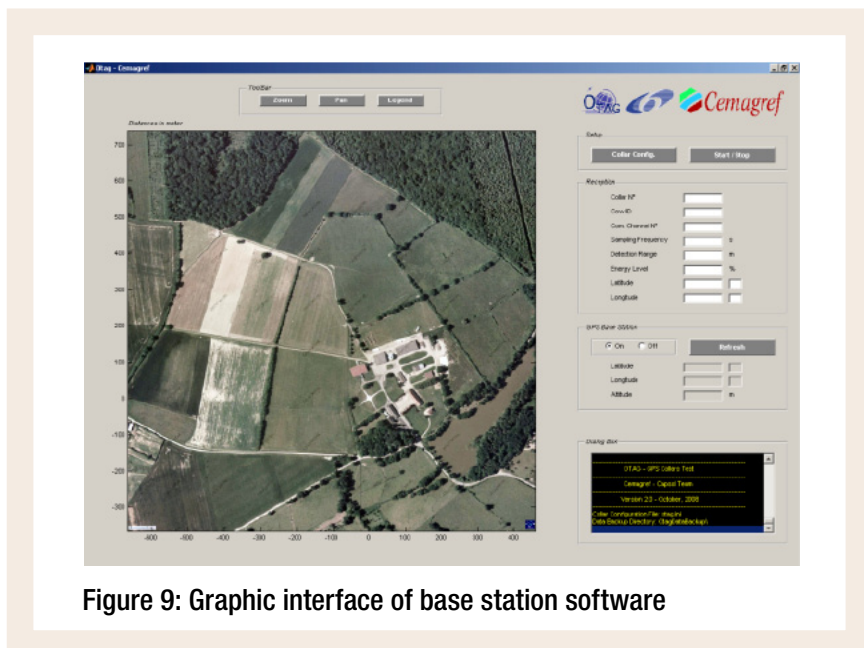

Figure 9: Graphic interface of base station software

Towards a Spatial Decision Support System for Animal Traceability

M. Visoli, S. Ternes – Embrapa ; S. Bimonte, F. Pinet, J.P. Chanet – Cemagref

This section presents the contributions of our work to the problems of bovine traceability and contact between animals using trajectory database concepts. This section describes how to delimitate problems and how to represent animal movements as trajectories. Afterwards, the algorithms for the identification of contacts between animals are presented for the calculation of contamination probabilities.

In this work we define contamination algorithms for foot-and-mouth disease (FMD). FMD is a highly contagious disease that attacks all cleft-hoofed animals, mainly bovines. It occurs at all ages, regardless of sex, breed, climate, etc. The virus spreads by direct contact of animals as well as through the air, water and food.

The virus is present in high concentrations in the liquid of vesicles of the mucous membranes of the tongue and in the soft tissues around the hooves. There are high concentrations of virus in the blood during the initial phases of the disease, during which there are serious infection risks to other animals. Sometimes infection can be indirect, the virus is carried through the food, water, air and birds. Likewise, people taking care of the sick animals carry the virus on their hands, clothes or footwear, therefore contaminating healthy animals. The incubation period varies from eighteen hours to three weeks.

In this work we consider two parameters for the calculation of contacts within the trajectory concept, which are set for FMD but that are common to other diseases as well. The first one is the number of days necessary to guarantee that no contamination has occurred: 90 days. This period determines a time interval where contacts must be calculated for later verification. The second factor is the area within the premises that must be interdicted. Initially, it is possible to use these values to determine the size of an activity area (buffer) and subsequent contact between animals. Finally, we make a realistic assumption on the geographic location of animal movements, which allows to improve the performance of contact computation as it reduces the number of trajectories considered by our algorithm. Indeed, we consider scenarios wherein farms use extensive and semi-extensive production systems. This means that animals can move between paddocks under the control of farmers.

The movement of animals between farms or from farms to slaughterhouses, which is done through roads, can be deduced and studied by analysing the existing road structure, however, this is not the subject matter of our work. We are interested in bovine movements into farms and, more specifically, into paddocks.

The data generator produces points representing animal positions inside the paddocks. For each point, geographical coordinates and time data (day and time) are collected. Thus, the following step is to transform these points into information representing the movements of the animals in

a format that allows advancing towards more intelligent operations. For this purpose, we consider that movement between two points is carried out in a straight-line. Based on this assumption, we have proposed a model of trajectories. In order to represent the trajectory of animals, we provide the definitions of point, segment, trajectory and journey.

Definition

- **point:** a point is a geo-localised acquisition represented by the geographical position and its associated time (day and time).
- **segment:** a segment is a line connecting two consecutive points in a ordered list of points throughout time.
- **trajectory:** a trajectory is a sequential set of segments, in accordance with the semantics defined by the decision-maker.
- **journey:** set of trajectories.

The semantics determining the beginning and end of a trajectory depend on what is being observed. For example, in our case study, beginning and end may be associated with the entry of the animal in the farm and its exit. Another example can correspond to the first and last day of protection against disease associated to some vaccination. An example is shown in Figure 10.

Three classes have been created: Journey, Trajectory and Segment. Segment is the simplest class and it represents collected points. Trajectory is an aggregation of segments, and Journey is an aggregation of trajectories.

Two important variables for the algorithms of contact between animals and calculation of the contamination percentage have been considered: Activity area and IBC.

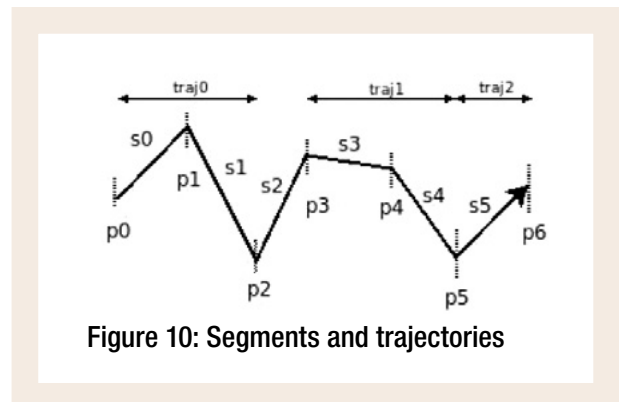
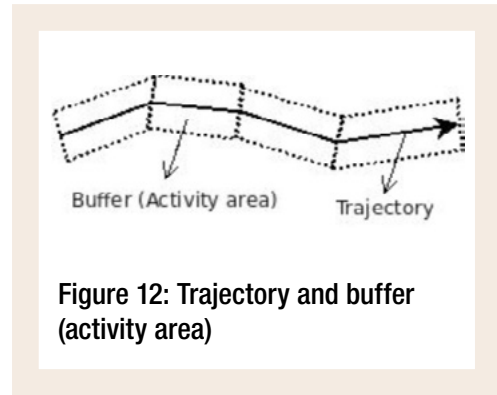
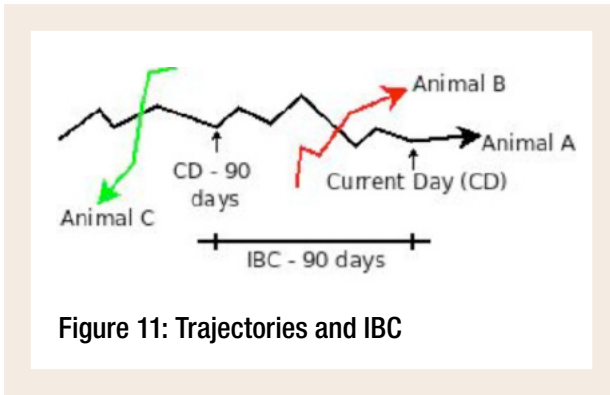

Figure 10: Segments and trajectories

Definition

- **Activity area:** is the buffer zone around a trajectory where there is a probability of contamination (see figure 12). Buffer represents a zone around the trajectory with an identical distance for each one of the sides;
- **Interval between contacts (IBC):** is a time range that represents the number of days during which there is contamination risk (see Figure 12).

FMD belongs to a group of diseases that are transmitted from a distance from the contaminated animal. Distance from the trajectory may vary depending on the wind, relief or rains. In our work we consider a distance of 3 km.



Finally, when considering the transmission of a disease as FMD, it is not only necessary to verify the intersection or crossing of trajectories, but also to try to delimit an area around the trajectory (buffer), and to verify the intersection of these areas with animal trajectories. Thus, before formalizing contamination contact taking into account IBC and Activity Area let us introduce Temporal Contact, Spatial Contact and Spatial-Temporal Contact.

Definition

- **Temporal contact:** If $trajA$ is the trajectory of animal A and $IBCtrajA$ is the subtrajectory of $trajA$ having IBC boundaries as starting and ending times. Being $trajB$ the trajectory of animal B. Temporal contact exists when there is a temporary intersection between $IBCtrajA$ and $trajB$.
- **Spatial contact:** If $trajA$ is the trajectory of animal A and $ACTtrajA$ is the Activity Area of $trajA$. Being $trajB$ the trajectory of animal B. Spatial contact exists when there is a topological intersection between $ACTtrajA$ and $trajB$.
- **Spatial-temporal contact:** If $trajA$ is the trajectory of animal A and $trajB$ is the trajectory of animal B. Spatial-temporal contact occurs when there are temporal contact and spatial contact.

Two algorithms have been developed to calculate spatial-temporal contacts between animals according to the time units used to define segments: day and hour.

The two techniques proposed have been tested on simulated data to find contaminated animals that have been in contact, according to three kinds of contacts defined.

As a conclusion, the traceability information system presented herein has proved to have the potential to increase product quality and trustworthiness as it improves the precision of the traceability process. The proposal focuses on an important target that involves a large number of actors around a relevant subject in what regards human health. This information system should be useful for government institutions and farmers in case of a relapse, saving time, costs and contributing to achieve food safety.

For further information:

M. Visoli, S. Ternes, F. Pinet, J.P. Chanet, A. Miralles, S. Bernard, et G. De Sousa, "Computational architecture of OTAG project," EFITA 2009, Wageningen, NL 6-8 juillet 09, 2009, p. 8.

M. Visoli, S. Bimonte, S. Ternes, F. Pinet, J.P. Chanet, "Towards Spatial Decision Support System for Animals Traceability" in Computational Methods Applied to Agricultural Research: Advances and Applications, Ed. Hércules Antonio do Prado, Alfredo José Barreto Luiz, Homero Chaib Filho, (To be published)

Pinet F., Roussey C., Brun T. & Vigier F. (2009). The Use Of Uml As A Tool For The Formalisation Of Standards And The Design Of Ontologies In Agriculture. In Advances In Modeling Agricultural Systems, Berlin: Springer-Verlag.

Papajorgji, P., Pardalos, P., 2006. Software engineering techniques applied to agricultural systems: an object-oriented and UML approach. Springer.

Part 4



The OTAG Operational Prototype and its Web Management Interface

Batistella, M.; Ferreira, A. S., Andrade, R. G., Embrapa

The OTAG Operational Prototype: Lessons from Experiments in France and Brazil

One objective of the OTAG project is to track bovine movements in extensive production systems. This objective implies the availability of adapted technologies in order to estimate animal location (considering a desired precision and acquisition period) and to store and make this information available to the operational geodecisional system. As a result of project activities an innovative approach for animal tracking was proposed.

In order to reach this objective an initial strategy was described in the OTAG project proposal. This initial so-called 'master-slave' approach defines sub-groups in the whole herd, associated with a reference animal (the 'master', equipped with a GPS-based collar). Around each master is defined a decisional polygon, and all other animals located inside this polygon are considered as 'slaves'. The master identifies the slaves by the use of a communication system.

Mainly because of problems related to communication aspects, we have selected and developed a second strategy called 'individual-based' approach: all animals are equipped with a GPS-based collar, which measures the position of the animal with a predefined frequency. The GPS collected data is periodically transferred to a base station in order to be used by the management system. Electronic collars and base stations are presented in Figure 1.

Such a system has been developed and transferred to the Embrapa experimental farm in Campo-Grande, Brazil, in March 2009, for a first series of experiments (see Figure 2). These experiments have led us

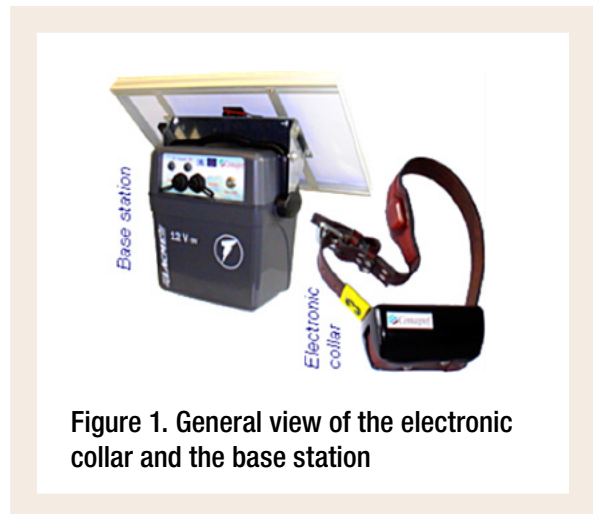

Figure 1. General view of the electronic collar and the base station

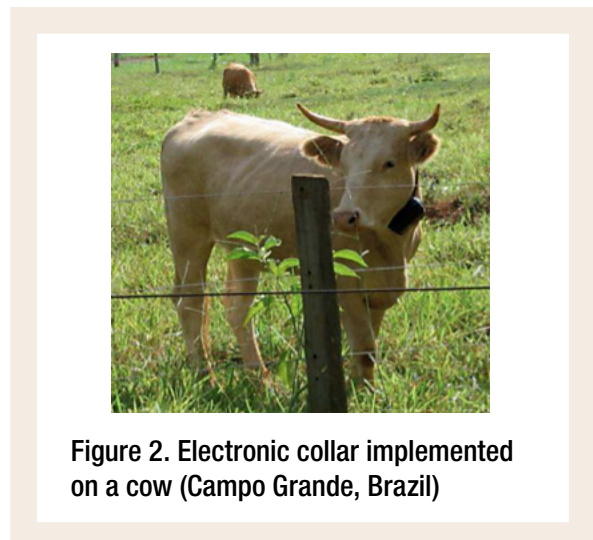

Figure 2. Electronic collar implemented on a cow (Campo Grande, Brazil)

to develop a new version of the electronic collars (hardware and software) and base station (software), particularly to take into account problems related to the energy efficiency of the collars. This new version of the system has been tested in the Cemagref farm (Montoldre, France). An example of trajectories obtained for two animals can be seen in Figure 3. This new system was transferred to Campo-Grande by the end of August 2009.

Experiments in Campo Grande using four collars have also indicated that the system is too strongly dependent on GPS for the management of communications between base station and collars. For example, a problem of GPS reception in a collar will block any communications of the collar with the base station. Further versions of the system could include an electronic system independent of the GPS for the management of communications.

The Web Management Interface

The main objective of this article is to present the solution developed during the studies carried out within the scope of the OTAG project for the presentation and manipulation of geographical information, mainly focused on animal circulation.

According to the proposed method, each monitored animal wears a collar consisting of a GPS receiver and a control system capable of storing and transferring the collected information. The paddock where the animals are confined has a unit for receiving information from the collars called 'base station' and other types of sensors for the automatic collection of data such as weight and temperature, among others. This set of devices comprises the first layer of the OTAG system information architecture (Visoli et al. 2009). The second layer consists of the application responsible for the reception and storage of information from the electronic devices on the environment and production systems.

The third layer is responsible for the aggregation of information from various farms, allowing for the analysis of animal circulation within the farm and between different farms. The fourth layer is responsible for integrating the centralized database of the third layer with other databases such as soil, climate and pastures, allowing for the development of geo-decisional analysis tools.

The need for a tool that can present the information collected during the experiments with the devices and information systems from layer 2 resulted in the implementation of a Web application, in accordance with the architecture defined for the presentation of geospatial data. The application is not only capable of displaying the stored information, but also allows the user to make interactive analyses.

Application architecture

The visualization system was developed using open standards, open source tools, and is compatible with the geospatial data presentation layer specified by Ferreira et al. (2008). The result was the use of a client/server architecture implemented in a Web platform. The use of this platform ensures the user easy access and portability, as the only requirements to use the application are: a web browser compatible with XHTML and JavaScript, and available connection to the Internet.

Unlike other client/server applications commonly developed for the Web, where the browser only has the function of displaying pre-processed HTML pages from the server, in the proposed architecture much of the processing occurs on the client. Through this approach, it is possible to reduce the processing load on the server, allowing it to serve a greater number of requests without involving the performance of the environment as a whole.

Figure 3 presents the approach used for the development of the application. According to its architecture, the application was divided into three integrated modules with distinct and well-defined functions:

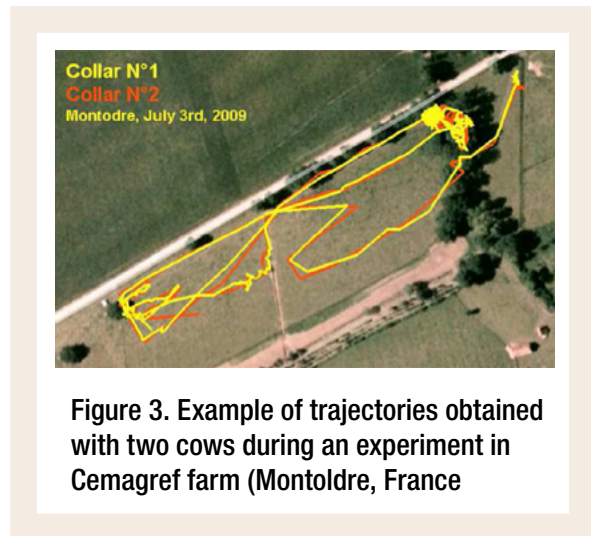

Figure 3. Example of trajectories obtained with two cows during an experiment in Cemagref farm (Montoldre, France)

- **The client module** – An application written in JavaScript and executed by the browser in the user’s computer. This module is responsible for the user interface and for processing part of the geospatial information provided by module 3.
- **The server module** – A set of PHP programs, interpreted by the web server, responsible for establishing the connection between the client module and server information (module 3);
- **Information provider module** – This module is composed by the database from OTAG Layer 2 (local module) and one or more servers providing complementary services.

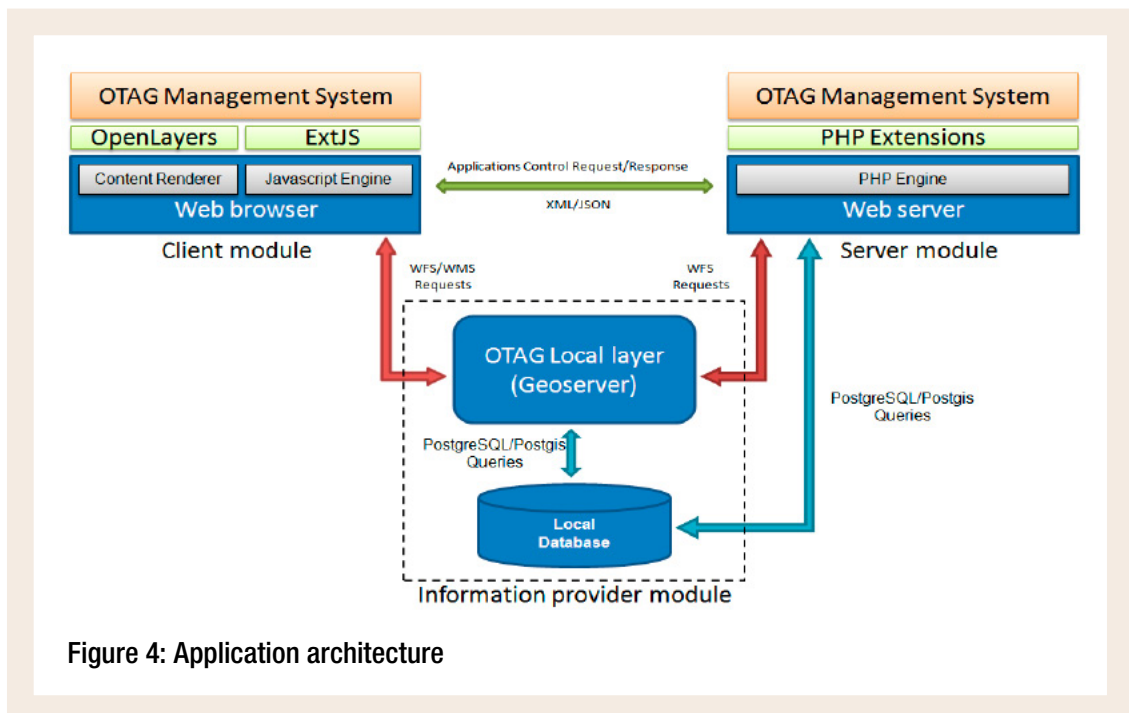

Figure 4: Application architecture

User interface

The user interface of the application has been implemented in the client module through a combination of visual objects and geospatial data visualization classes. Components such as windows, dialogue boxes, panels, tabs, toolbars, pull-down and popup menus, lists and tree panels form the basis on which Web 2.0 applications and websites are built. Figure 5 shows the main screen of the application with elements numbered from 1 to 7 representing the visual components for the standard viewer. A description of each element is provided below.

Menubar: Allows access to various features of the application, such as saving and loading maps, changing the display of interface elements, etc.;

Layer controls: Provides tools to add, remove and change the presentation order of information layers;

Toolbar: Access to zoom and moving functions, query and measurement tools;

Layer list: List of information layers added to the map. This object also allows access to various features from the selected layer through the context menu; show/hide layer control and change the order of the layers by drag and drop actions;

Map visualization: Map display and manipulation area;

Overview: Reduced reference of the geographical region displayed in the map visualization area.

Statusbar: Shows the map scale and geographical coordinates from the point represented by the mouse position.

The operation principles of the application are similar to a desktop GIS program. When the application is started, the workspace is presented to the user with no information in the visualization area. From this point, the user can add information layers that will constitute a map. The information layers available for use in the application are divided into two groups:

- **Image:** This is a layer with no additional attributes except the geographical coordinates and the image itself;
- **Data:** Information layers that associate one or more attributes to their spatial objects. The visual representation of objects can be a polygon, a line or a point.

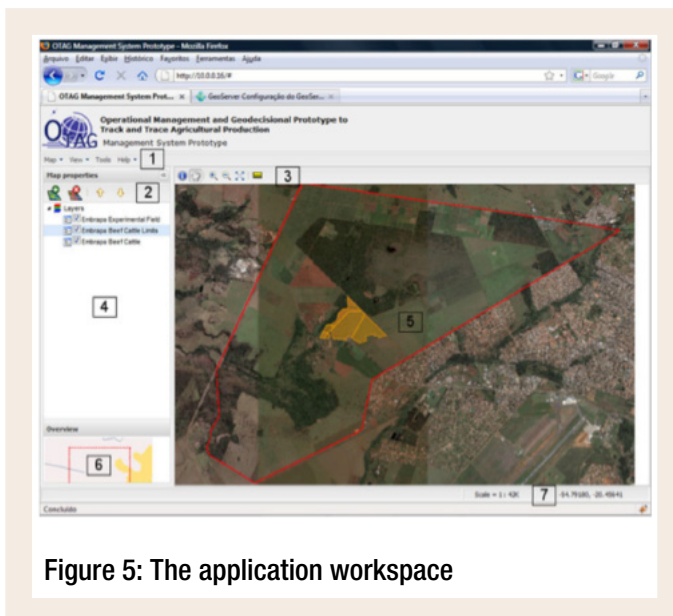

Figure 5: The application workspace

When the user requests the addition of a new information layer, the application presents a dialog box, showed in Figure 6, containing a list of information sources and layers available for each source. When a layer is selected, the dialog box displays metadata and an image preview associated to the chosen layer. By confirming its inclusion, the application automatically adds the layer to the layer list and presents it in the visualization area. At this point, the user can change the visual properties of the presented information, defining the transparency level or creating display filters.

This cycle of actions can be performed several times, resulting in a map with several layers and customizations. At any time, the user can move the map in the visualization area using the pan, zoom in, and zoom out tools. At end of the work, the user can save the resulting map in a local file. The saved file is an object with a complete map representation, including layer styles, filters and map position. This file can be used to load the predefined map in a future use.

In addition to features intrinsic to the information layers, the application offers other resources aimed at extending use possibilities. The inspiration for these features is, for example, the need of specific tools for handling animal circulation data, which are closely associated to temporal variance. Examples of such applications include:

- **Classification:** allows the creation and display of information layers classified by their attribute values;
- **Measurement:** this feature allows the measurement of distances or areas through multiple points. The result is shown in a small dialog box that also allows to change measurement units;
- **Query:** provides support to the query attributes of the spatial objects in information layers. Click and click-and-drag operations are possible in order to query a point or specific area, respectively.

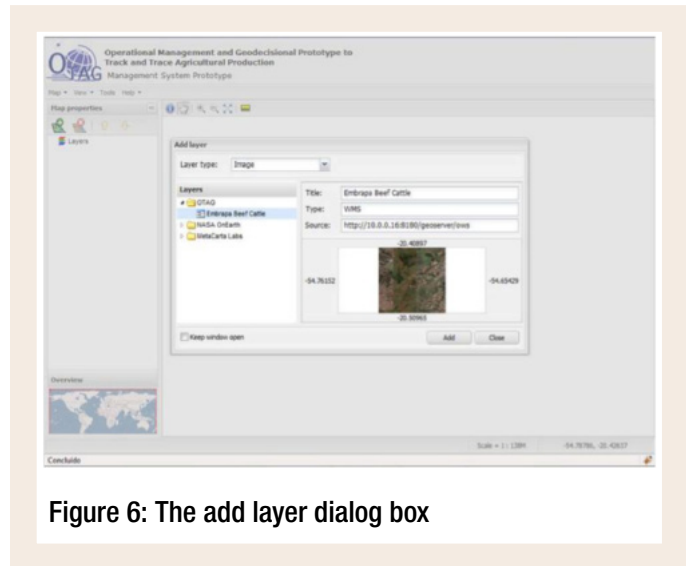

Figure 6: The add layer dialog box

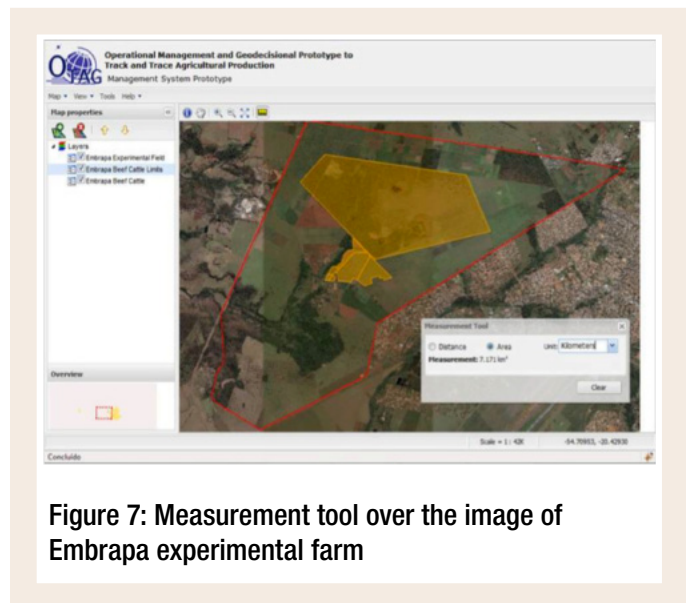

Figure 7: Measurement tool over the image of Embrapa experimental farm

- **Time animation tool:** allows a series of data with time variation to be presented in animated form. This tool was developed specifically to meet the need for a tool to observe animal movements during the experiments.

Through the use of open standards for data representation and communication between modules, the application is able to easily integrate new features to its workspace. As an example of this feature, it is possible to highlight the access to external databases.

On the “Add layer” dialog box, on data type Image, there are two external data sources, they are the “NASA OnEarth” which provides global mosaic images from MODIS and Landsat 7, and the “MetaCarta Labs.” which provides a stylised map of the continents. Both sources provide their data via WMS services.

Another example was the inclusion of an environmental database, produced for the Embrapa Beef Cattle farm. In this case, a set of indicators including surface temperature, solar radiation, vegetation index (NDVI), among others, was calculated for two different dates illustrating seasonal and spatial variability. Through a process of conversion it is possible to import this data to the application. The result can be seen in Figure 10.

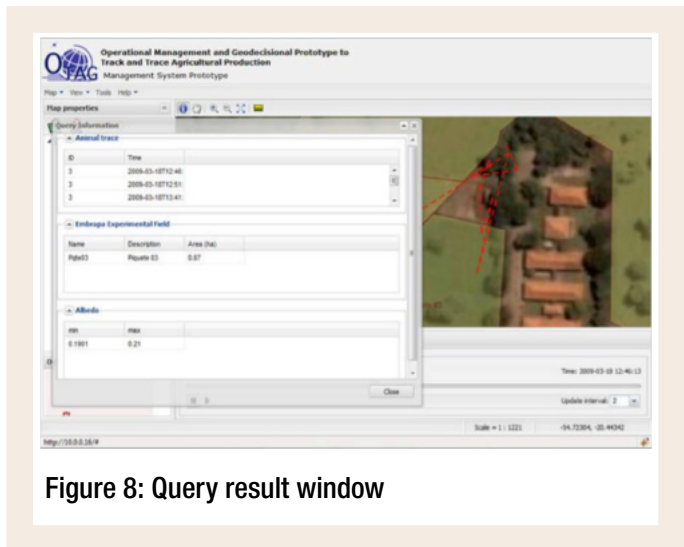

Figure 8: Query result window

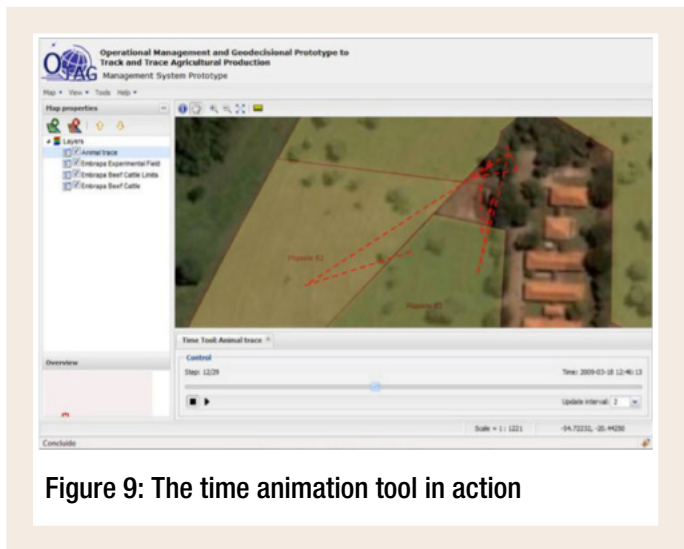

Figure 9: The time animation tool in action



Figure 10: Accessing the environmental database

Conclusion

Although designed as a visualization tool aimed at monitoring the evolution of experiments with the collars and the local OTAG project, the ability to integrate other databases in its workspace ensures the necessary flexibility for the application to be used not only in local modules but also at the higher levels of the architecture proposed for the OTAG prototype.

Due to the flexibility of the tools used in its development, it is possible, in a relatively short time, to add new features to the application, which could meet the needs of specific users.

Although there are technological limitations to the incorporation of certain features in the proposed architecture, mainly related to geospatial analyses, it is still possible to integrate the application with other tools that would act as data providers for more complex computing.

Therefore, it is possible to affirm that the Web platform and open standards for data representation, as used by the application, are feasible as a technological solution for system development where the focus is the presentation and manipulation of geospatial data.

References

VISOLI, M., TERNES, S., CHANET, J.P., PINET, F., MIRALLES, A., BERNARD, S., DE SOUZA, G. A New Information System for Tracing Geolocations of Bovine Cattle. Atelier Systèmes d'Information et de Décision pour l'Environnement, INFORSID 2009, Toulouse, May 2009. 11 p.

FERREIRA, A. S.; BATISTELLA, M. The architecture of a geospatial data presentation layer for OTAG. November. 2008. Available from:

<http://www.otag-roject.org/files/publications/GeospatialPresentationLayerForOTAG>

Part 5



Dissemination and improvement

Dr Alain Viau, Laval University; Dr. Guy Henry, Cirad

Direct and indirect impacts of OTAG

Impacted population	Direct impact	Indirect and/or longer term impact
Overall end-users	Availability of relevant “on line” information on innovative technologies, research results and expert groups, beef agri-chain organisation, technology transfer process	Implementation of OTAG system elements in Argentina as well as in Brazil, through interests by the private sector.
European and Southern Cone consumers	Through diffusion activities of project results by project partners, a first set of information will increase awareness.	More information and (imported) certified traced beef consumption. Further increased awareness by consumers.
Southern Cone producers	Awareness of in-pipe technologies that improve their traceability systems and hence, may open new markets	New opportunities to open and/or increase beef exports to the EU of geo-traced and certified products.
Policy makers	Knowledge on the current limitations of national beef production systems in the light of EC beef import regulations. Information on novel and cost-effective tools and systems for the beef industry future.	New information for improved policy making. New decisional system to improve risk and crisis management.
Scientific community	Results published in scientific journals on Track & Trace prototype tools and systems, developed, tested and up-scaled under different conditions	One Master and one PhD thesis based on the project ensuring highly qualified personal. Two PhD projects.
Bi-regional cooperation	Strengthened dialogue for regional and bi-regional integration (between public and private partners). Opportunities to cross-fertilise technologies to other research applications.	Additional bi-regional research projects on related areas to be developed. Established research cooperation in OTAG will foster additional cooperation among the same and other institutes on the same and additional research topics.
European Research Area	Legibility of the European cooperation in LAC; Enhancement of the on-going bilateral or regional European agreement in the Southern Cone (Argentina, Chile, Brazil).	Consolidated partnerships between research organisation, University as well as Government research institutes.

Dissemination of Results

The OTAG strategy for the dissemination of the main results was based on the following elements and actions:

- Availability of Website based information, through the project's own website and through hotlinks with relevant partner projects;
- Information Booklet was edited for the dissemination of OTAG results;
- Workshops for beef sector actors, scientists, policy makers, as well as producers
 - 1- Campo Grande/ (Brazil) - EMBRAPA
 - 2- Campo Grande (Brazil) - EMBRAPA
 - 3- Québec (Canada) – Laval University
 - 4- Clermont Ferrand (France) - Cemagref
 - 5- Campo Grande (Brazil) - EMBRAPA
 - 6- Buenos Aires (Argentina) - PROCISUR
- Information packages were distributed to our partners and relevant national and international collaborators. In addition, OTAG flyers and information/contacts were distributed at several international and regional food sectors, traceability system fairs in Montevideo and Buenos Aires during 2007-08.
- Six workshops were held in France, Canada, Brazil and Argentina to diffuse knowledge on the “Trace and track geo-decisional system” approach towards those countries and analyse/ assess the possibility/opportunity to implement it.
- Scientific and professional publications (see annex) as well as one MSc (Marcos Visoli) and one PhD thesis (Thais Basso Amaral (Embrapa-Laval)).
- Project's public/private sector partner Procisur was interested in using the new OTAG technology as part of their updated and innovative products, especially in Southern Cone countries where they are aggressively endeavouring to gain a greater market share;
- A direct link with partner project ALCUEFOOD has been established, which guarantees appropriate uptake and diffusion through its Information System and Website www.inta.gov.ar/alcuefood/
- Links have been established with EC project PETER www.peter-project.org to guarantee the integration and diffusion of OTAG results through PETER's partners, as well as consortiums GeoTraceAgri, TRACE, SEAFOOD, FOODTRACE, CO-EXTRA, etc.

Added value at European and International level

- EU-based know-how, expertise and research capacity, mainly in terms of relevant EC sister projects, are integrated with specific Canadian research advances and Southern Cone beef sector actors demands and experimentation capacity;
- Quebec ATQ's and FADQ's know-how, expertise and technology inspired the OTAG Data base management system;
- Promotion of a European OTAG System at an international level;
- OTAG - Collar technology developed in France (Embrapa-Cemagref) was exported to Brazil and Argentina. Procisur, together with INTA-Argentina, is designing appropriate documentation and detailed descriptions of systems and technologies (+ the various physical prototypes) in order to introduce these into several of the research laboratories that have expressed their interest in experimenting with the system for other research purposes. This information will also be shared, through the assistance of Procisur, with the agricultural national research institutes in Chile, Uruguay, Paraguay and Bolivia.
- 3 Embrapa centres that collaborated with the OTAG project are formulating an internal project proposal, inviting private sector partners, to make the prototype technologies advance to commercial uptake levels.
- ATQ International was founded so as to export their services and expertise to consolidate the international partnership;
- FADQ International was founded to consolidate the international partnership;
- The partnership with Canadian, French, Brazilian and Argentinean researchers was an additional beneficial effect of the OTAG International partnership.
- National Food Safety Services (SENASA) from Argentina www.senasa.gov.ar and Paraguay www.senasa.gov.py have expressed their interest in the prototype's technologies, as it would fit in a complementary way in their ongoing traceability activities and risk management systems on livestock disease outbreaks in their countries.

Interaction with other relevant research activities

Apart from close and frequent interactions with EC FP6 SSA ALCUEFood and EC FP6 SSA PETER project partners (through the participation at several of their meetings and workshops) the project has had the collaboration of the following projects and/or activities:

- Brazilian EMBRAPA project "Beef meat quality", whereby the OTAG system was introduced as a potential new technology,
- Southern Cone strategic R&D platform from regional agency IICA-PROCISUR "Platform on bovine meat quality". This platform includes several research projects including themes as "meat tenderness", "quality and niche markets" and "traceability". In collaboration with the latter theme, a Workshop on bovine meat traceability was organized in Montevideo in 2008, where OTAG's scope and progress were presented and discussed.

- Argentine project INTA. The relevance of the OTAG system and technologies were introduced in several R&D activities related to “traceability systems” and “quality and markets”.
- Brazilian project with AllFlex, and
- Canadian project with Agritraçabilité Québec (ATQ) and the Financière Agricole du Québec (FADQ)

ANNEX: Scientific references

Articles

Ferreira, A. S., Batistella, M. The architecture of a geospatial data presentation layer for OTAG. November. 2008. Available from:

<<http://www.otag-roject.org/files/publications/GeospatialPresentationLayerForOTAG>>

Pinet F., Roussey C., Brun T. & Vigier F. (2009). The Use Of Uml As A Tool For The Formalisation Of Standards And The Design Of Ontologies In Agriculture. In *Advances In Modeling Agricultural Systems*, Berlin: Springer-Verlag.

Papajorgji, P., Pardalos, P., 2006. Software engineering techniques applied to agricultural systems: an object-oriented and UML approach. Springer.

Book chapters

Visoli, M., Ternes, S., Bimonte S., Pinet, F, Ch Janet, J.P. - Towards Spatial Decision Support System for Animals Traceability in « Computational Methods Applied to Agricultural Research: Advances and Applications », IGI Global

Ometto, A., Batistella, M., Guelere Filho, A., Chuzel, G., Viau, A., 2007, Geotraceability and life cycle assessment in environmental life cycle management: towards sustainability. 14th International conference on concurrent engineering, São Paulo, In: Loureiro, G., Curran, R. (Eds.). *Complex Systems Concurrent Engineering*. London: Springer, 2007. p. 673-679.

Conferences

Visoli, M., Ch Janet, J.P., Pinet, F., Bimonte, S. Uso de Trajetórias na Rastreabilidade Bovina. 70. Congresso Brasileiro de Agroinformática, 2009. Viçosa, MG, Brasil. Submitted.

Amaral Basso, T., Hattvany, M., Gond, V., Pires, P., 2009, Use of geographical and socio-economical information to support the risk assessment of foot and mouth disease in the frontier between Brazil and Paraguay, OIE meeting, Asuncion (Paraguay).

Andrade, R. G., Batistella, M., Amaral, T. B., Menezes, S. J. M. C. Estimativa do albedo em áreas

de pastagem e floresta no Mato Grosso do Sul. 7º Congresso Brasileiro de Agroinformática, 2009. Viçosa, Brasil. 5p. Accepted.

Andrade, R. G., Batistella, M., Amaral, T. B., Menezes, S. J. M. C. Análise preliminar da variabilidade espacial da evapotranspiração de pastagens com o uso de imagens orbitais. . 7º Congresso Brasileiro de Agroinformática, 2009. Viçosa, Brasil. 5p. Accepted.

Andrade, R. G., Batistella, M., Barbosa, R. A., Sediyaama, G. C., Delgado, R. C., Lima, E. P. Aplicação de técnicas de sensoriamento remoto na estimativa da biomassa vegetal de pastagem no Mato Grosso do Sul. XVI Congresso Brasileiro de Agrometeorologia, 2009, Belo Horizonte, Brasil. 5p. Accepted.

Visoli, M., Ternes, S., Chanet, J.P., Pinet, F., Miralles, A., Bernard, S., De Souza, G., 2009, A New Information System for Tracing Geolocations of Bovine Cattle. Atelier Systèmes d'Information et de Décision pour l'Environnement, INFORSID 2009, Toulouse, 26 mai 2009, 11 p.

Visoli, M., Ternes, S., Pinet, F., Chanet, J-P., Miralles, A., Bernard, S., De Sousa, G., 2009, Computational architecture of OTAG project, Article accepté au congrès EFITA 2009 - 6-8 Juillet 09 - Wageningen (NL)

Batistella, M., Ometto, A., Viau, A., Chuzel, G., 2006, Geotraceability in agricultural chains, an urgent demand in Brazilian agribusiness. In: global conference on sustainable product development and life cycle engineering, 4, São Carlos. Proceedings. São Carlos: Suprema, 2006. 5p. 1 CD-ROM. (ISBN: 85-98156-25-6)

Amaral, T., Viau, A., Gond, V., Hatvany, M., Pires, P., Boutinot, L., Batistella, M., 2008, L'utilisation d'informations géographiques, historiques et socio économiques afin d'analyser le risque de fièvre aphteuse au Brésil. Congrès des étudiants de la Faculté de foresterie et de Géomatique de l'Université Laval, Québec, Canada.

Silva, M., Caceres, E., Turine, M., Pires, P., Santos Neto, Q., Sandim, H., Viana, C., Almeida, R., Carromeu, C., Amaral, T., 2008, Beef Traceability: A Case of Study Using RFID.

Monod, M., Faure, P., Moiroux, L., Rameau, P., 2008, A virtual fence for animals management in rangelands

Esta publicación
se terminó de imprimir en
Imprenta Boscana S.R.L. en 2009.

Dep. Legal: 350.396

**Programa Cooperativo para el Desarrollo Tecnológico
Agroalimentario y Agroindustrial del Cono Sur**

Argentina
Bolivia
Brasil

Chile
Paraguay
Uruguay



Edificio MERCOSUR
Luis P. Piera 1992 Piso 3
Tel.: (598 2) 410 1676
Fax: (598 2) 410 1780
Montevideo - Uruguay
E-mail: sejecutiva@procisur.org.uy
www.procisur.org.uy